



Another EMC resource  
from EMC Standards

## A Practical Guide for EN 61000-4-6: Test & Measurement techniques

*Helping you solve your EMC problems*



## A Practical Guide for EN 61000-4-6

Testing and measurement techniques  
– Immunity to conducted disturbances  
induced by radio-frequency fields.

### REO INDUCTIVE COMPONENTS AG

Bruehler Strasse 100, D-42657 Solingen, Germany  
Tel: 00 49-(0) 2 12-88 04-0  
Fax: 00 49-(0) 2 12-88 04-188

### REO USA

3250 North Post Road, Suite 132, Indianapolis  
IN46226, USA  
Tel: 001 317 8991395 Fax: 001 317 8991396

REO (UK) LTD, Units 2 - 4 Callow Hill Road, Craven Arms  
Business Park, Craven Arms, Shropshire SY7 8NT UK  
Tel: 01588 673411 Fax 01588 672718  
Email: [sales@reo.co.uk](mailto:sales@reo.co.uk) Website: [www.reo.co.uk](http://www.reo.co.uk)



**REO UK LTD**

### Contents

### 1

Conducted radio-frequency and compliance with the EMC Directive	2
What to do when new versions of basic test standards are issued	5
What is conducted RF and how is it caused?	6
What problems are caused by conducted RF?	7
Conducted RF testing and real-life reliability	11
Introduction to conducted RF immunity testing	12
Alternative transducers and test methods	17
General notes on test set-ups	25
Signal generators and power amplifiers	26
Correlating alternative test methods with EN 61000-4-6	29
On-site testing	29
Full compliance conducted RF immunity testing	30
Filtering, shielding, and isolating transformers	42
Low-cost and/or non-compliant testing	43
Buying second-hand test gear	44
Which ports to test?	44
Test as Real Life (TARL)	45
References	49
Acknowledgements	51

The basic immunity test method for conducted continuous radio-frequency (RF) is IEC 61000-4-6 [1]. This has been adopted as the harmonised European standard EN 61000-4-6 [2], which is often called up as a basic test method by immunity standards listed under the Electromagnetic Compatibility (EMC) Directive [3].

Since all cables carry conducted RF voltages and currents, and since these voltages and currents can interfere with every kind of electronic device, equipment or system (called products in the rest of this handbook) that is connected to wires or cables, or to other equipment, it makes good sense to test products to ensure they will work reliably in their intended operating environment. This is especially important in safety-related, high-reliability, mission-critical, or legal metrology electronic applications.

EN 61000-4-6 is a basic test standard, so when following the self-declaration to standards route to conformity (Article 10.1 in [3]), EN 61000-4-6 should *not* be listed on the EMC Declaration of Conformity. Only the relevant generic or product-family harmonised EMC standards should be listed. These will usually call-up EN or IEC 61000-4-6 as a test *method*, but it is always the generic or product-family standard that sets the minimum test levels which allow conformity to be claimed.

When using the Technical Construction File route to conformity with the EMC directive (Article 10.2 in [3]) it is possible to use EN/IEC 61000-4-6 directly, in which case it *should* be listed on the product's EMC Declaration of Conformity. In such cases the product manufacturer should assess the electromagnetic environment of the product and ensure that it is designed and/or tested accordingly, so as to comply

with the EMC Directive's essential 'Protection Requirements' (Article 4 of [3]).

There may be significant financial or compliance benefits in performing conducted RF immunity tests which go beyond simple compliance with the *minimum* requirements for Self-Declaration to the EMC Directive. This is especially true where mobile radio transmitters (e.g. cellphones, walkie-talkies, etc.) could be used nearby, or where industrial scientific or medical equipment that uses radio frequency energy to perform its direct function (CIPSR 11 or EN/IEC 55011 refer), is nearby.

These two situations are specifically *not* covered by the generic, product or product-family immunity standards listed under the EMC Directive, meaning that it is up to the manufacturer to assess the electromagnetic (EM) environment that his/her product will be used in and test it accordingly, to comply with the EMC Directive's Protection Requirements.

Compliance with the EMC Protection Requirements is a legal requirement that applies *in addition* to the requirement to follow one of the conformity assessment routes (Self-Declaration, Article 10.1 or TCF, Article 10.2). Products that pass tests to all relevant immunity standards listed under the EMC Directive, but nevertheless are unreliable or fail in normal use because they are not immune enough for their real-life EM environment, do not comply with the EMC Directives Protection Requirements and are therefore illegally CE marked.

### Relationship between EN 61000-4-6 and the EMC Directive (EMCD)

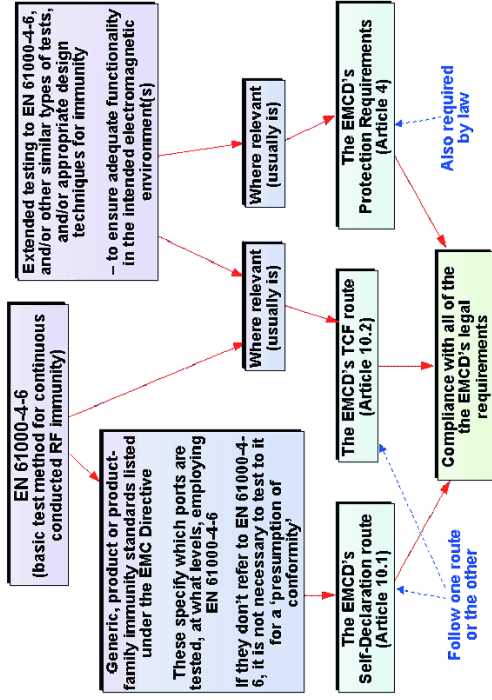

The second edition of the EMC Directive, 2004/108/EC [5], replaces [3] on the 20<sup>th</sup> July 2007. Equipment already being supplied in conformity with 89/336/EEC will be allowed to be supplied until 20<sup>th</sup> July 2009, by which date it too must comply with [5] if it is to continue to be supplied in the EU. Whereas [3] requires the involvement of a Competent Body with all TCFs, [5] effectively allows the TCF route to be used with the *optional* involvement of a Notified Body (the new term for Competent Bodies).

Like 89/336/EEC, 2004/108/EC [5] also requires equipment to comply with its Protection Requirements, given in its Article 5 and Annex 1, where it sometimes calls them "Essential Requirements". So it is recommended that all equipment manufacturers assess the electromagnetic (EM) environment of their equipment [4] and ensure that it is designed and/or tested accordingly.

Under 2004/108/EC, all 'fixed installations' must comply with its Essential Requirements, and they must also have documentation that shows how this has been achieved using good engineering practices. Equipment manufactured specifically for use at a named 'fixed installation' may not have to comply with any EMC requirements at all – when it is supplied – but testing to EN 61000-4-16 at specified levels could be one of the EMC specifications imposed on the supplier by the purchaser, to help ensure that a particular 'fixed installation' complies with the Essential Requirements.

Applying EN 61000-4-6 (or similar) tests which go beyond the minimum requirements of the EMC Directive's listed products can also be a way to help make products more reliable, reduce warranty costs, improve customer satisfaction and reduce exposure to product liability claims – for more on this refer to the section on "Conducted RF testing and real-life reliability" later.

### The relationship between EN 61000-4-6 and the second edition of the EMC Directive (2004/108/EC)

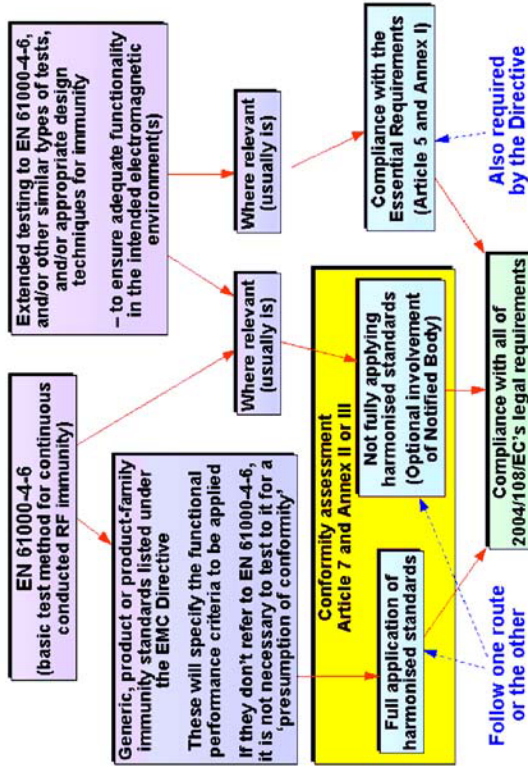

This booklet is part of a series that discusses a number of common EM phenomena in domestic (residential, household, etc.), commercial, light industrial and industrial environments and how they are tested according to appropriate EN standards on emissions and immunity. But other kinds of immunity tests may be required by the EMC standards for automotive, aerospace, rail, marine and military environments. Some of these industries have developed their own test standards based on their own particular kinds of EM environments, to improve reliability and/or safety.

This handbook describes how to apply EN 61000-4-6:1996, and applies equally well to IEC 61000-4-6:1996. 2003 versions of these two standards exist, but the changes from the 1996 versions are not significant

enough to describe here. However, it is always best to use the latest version of the test standard, except where regulatory requirements for the EU or elsewhere specify the version to be used. Since many national tests outside the EU are based on IEC standards, this handbook may be of use where non-EU EMC specifications apply.

Where an electronic product has a safety-related or legal metrology function, requires high reliability, or is mission-critical mere compliance with the EMC Directive is often insufficient for ensuring that it has been designed correctly – additional and/or tougher immunity requirements may need to be applied. Refer to the section "Conducted RF testing and real-life reliability" later, plus the IEEs guide [4] and the on-line article [5] for more on this.

What to do when new versions of basic test standards are issued

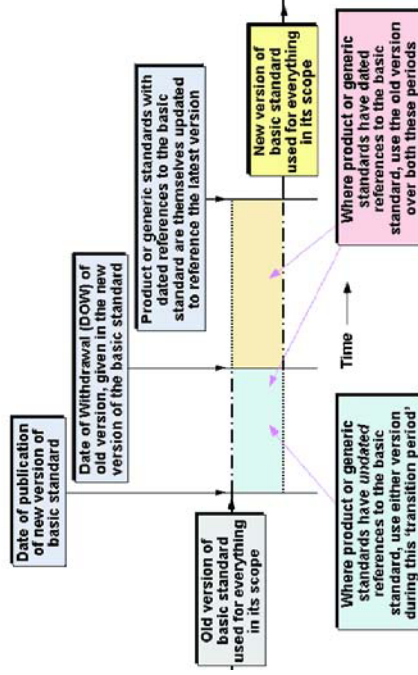

This booklet describes how to apply EN 61000-4-16:1998. Where a generic or product EMC standard requires the use of a basic test method it will specify either a dated reference (e.g. "EN 61000-4-16:1998"), or an undated reference (e.g. "EN 61000-4-16"). If it specifies a dated reference, then only this version of the basic test method standard may be used. If it specifies an undated reference then the latest published version of the standard should be used. (At the time of writing, there are no versions of EN 61000-4-16 other than the 1998 one.)

But it is clearly impractical for manufacturers to rush to test labs to retest all of their types of equipment on the very day a new version is issued, so each new version of an IEC standard includes a date on which it supersedes the previous version. This is the "date of withdrawal" (DOW), and provides a transition period during which manufacturers can choose between using the old or the new versions of the standard for declaring compliance. The DOW is preserved in the EN versions of the IEC standards.

Usually it makes best commercial sense to test new equipment to the latest version of a standard, retesting older equipment when they are due for retesting anyway as a result of a design change or upgrade (as long as this happens before the DOW). Some equipment is sold for such short periods of time that they may never need to be retested to any new versions of standards.

A note of caution: the European Commission (EC) has ruled that where Directive compliance is concerned, only dates that are published in the Official Journal of the EU (OJEU) have any relevance, and not any dates put into standards by their committees. This is not a problem in most cases, but basic EMC test standards such as EN 61000-4-16 are never listed in the OJEU. Since DOW dates in the basic standards are not recognised by the EU, there can be no transition period – which is clearly impractical and silly – but this consequence does not seem to have been foreseen by the EC. It is probably less risky to always use the latest version of a basic test standard, except where the regulatory requirements (for the EU or other markets) specify the exact version to be used.

What is conducted RF and how is it caused?

The modern electromagnetic environment is very busy – and radio waves inject currents into cables

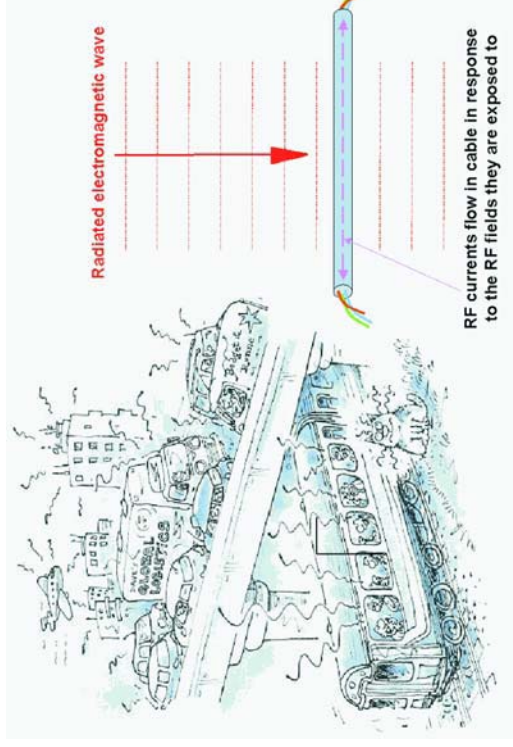

Conducted RF immunity simply refers to a product's immunity to unwanted 'noisy' RF voltages and currents carried by its external wires and cables.

Electronic activity at RF in an item of equipment, such as digital processing or switch-mode power conversion, will generate RF noise on its external cables. This noise will be in differential-mode (DM) as well as common-mode (CM). Products which connect to such equipment will therefore be subjected to conducted electromagnetic disturbances at RF in both DM and CM on their interconnecting cables. However, EN 61000-4-6 only simulates the RF voltages and currents caused by exposure to RF fields in the product's operational environment, and these are assumed to be common-mode.

Electronic activity at radio frequencies in an item of equipment also causes radiated electromagnetic fields to be

created. When wires and cables are exposed to such fields, RF currents and voltages are created in the conductors. Every type of electronic equipment 'leaks' such fields, either unintentionally or because it is a radio transmitter.

Radio, TV and radar transmitters, and very powerful processing such as industrial scientific or medical equipment (ISM) that use RF energy to perform their direct functions (covered by CIPSR 11 or EN/IEC 55011), can emit very powerful voltages and currents on their interconnecting wires and cables, and can emit very powerful fields into the air, at the radio frequencies they are permitted to employ.

Radio, TV and radar transmitters are generally only connected to dedicated equipment designed for that purpose, and if they are powerful they are generally located some distance away from other equipment.

Broadcast transmitters are often situated on hills and tall buildings to maximise the area they cover, but when they are located in cities or when other buildings or electronic equipment are nearby they can cause significant problems with interference [6], [7].

A modern problem is the rapid growth in personal radio communications using cellphones, Bluetooth, Wi-Fi, and many other wireless technologies. Although these generally use low-powered transmitters they generate quite powerful fields nearby and there are few practical ways to prevent them from being used in very close proximity to other electronic products or their cables. Even Bluetooth transmitters at 25mW can inject tens of milliamps of current at 2.45GHz into a nearby wire [8].

It used to be generally thought that most wires and cables are increasingly lossy at frequencies above 100MHz, so that the mobile transmitters such as cellphones, Bluetooth and Wi-Fi that transmitted at 900MHz and above were unlikely to interfere with equipment unless they were near to the actual equipment itself. However, work carried out by the University of York [9] showed, amongst many other valuable facts, that CM currents picked up by a typical twisted-pair Ethernet cable from an ensemble of nearby 900MHz cellphones only diminished at about 0.9dB per metre with distance along the cable. Clearly, mobile transmitters operating at 900MHz and above can have a significant effect on equipment by coupling into its cables at some metres distance.

## WHAT PROBLEMS ARE CAUSED BY CONDUCTED RF?

Sufficient levels of conducted RF noise can cause errors or malfunctions in the analogue or digital semiconductors connected to the conductors by means of three different interference mechanisms (discussed later). In analogue circuits, noise and signal distortion from interference can reduce the signal-to-noise ratio to negative values (more noise than signal). This is especially a problem for sensitive circuits such as amplifiers for millivolt-output transducers such as thermocouples, resistance thermometers, strain gauges and microphones.

Measurement errors and noise, even up to full-scale deflection errors in analogue signals are quite common in such circuits during testing with conducted RF to comply with the EMC Directive. Digital circuits running software can suffer from false keypresses or control signals, false resets, software looping (continuously repeating a section of code), and stopped execution, commonly called a 'crash'.

Analogue circuits are generally more susceptible to continuous modulated RF than digital circuits, because of the noise thresholds used by digital devices – but anything that uses electronics can misbehave when exposed to certain RF frequencies or combinations of frequencies. Without adequate protection from conducted RF noise, few modern electronic circuits behave reliably in the modern world. If the conducted noise levels are high enough they can even cause permanent damage to semiconductors, and even to other electronic components.

The first, and most obvious interference mechanism – by which conducted RF noise can interfere with electronic circuits – is called 'direct interference'. It occurs when the RF noise frequency coincides

with (or is close enough to) the frequency of a signal in a conductor to distort it. This is a common problem at the clock frequency of digital processors or display drivers, and also at their harmonics. Noise frequencies that are close to rates of certain circuit operations can also interfere with correct circuit operation.

The second type of interference mechanism is audio rectification, sometimes called demodulation. All semiconductors respond *non-linearly* to voltages and currents, with some types responding more non-linearly than others. The typical semiconductor is often assumed to have a square-law response at low levels of current. The effect of passing a noise current through a non-linearity is that positive-going waveforms are amplified more than negative-going – or vice-versa, depending on the polarity of the device – resulting in a level of d.c. offset that depends upon the level of the RF noise. This process is known as rectification, and amplitude modulation of the RF signal causes this d.c. offset to vary in turn, so the envelope modulation of the RF waveform is demodulated, just as it is in a radio receiver.

Demodulation occurs naturally in all semiconductors, so every semiconductor can be thought of as an 'RF detector', essentially an 'accidental crystal set' radio receiver. Integrated circuits can contain many tens, even millions of semiconductor junctions, all waiting for the opportunity to demodulate RF noise signals.

Many interference problems with audio and instrumentation circuits are caused by the fact that the demodulated noises tend to lie in the same frequency range as the wanted signals, reducing the quality of the output or leading to erroneous measurements. In audio circuits the 1kHz

modulation of the EN 61000-4-3 is usually clearly heard over the loudspeakers, earpiece or headset. Interference with digital circuits is most likely to occur when the demodulated RF noise contains a frequency that coincides with (or is close enough to) the frequency of a signal or the rate of certain circuit operations. However, high enough levels of d.c. offset from noise rectification can alter the biasing of circuits, both digital and analogue, by enough to prevent them from working correctly.

The third interference mechanism is intermodulation, caused by the same non-linearities that cause audio rectification. When more than one RF signal is present at the same time in a non-linear device, 'intermodulation products' – new frequencies – are created inside the circuit itself. The presence of  $f_1$  together with  $f_2$  (for example: 200MHz and 200.1MHz) will result in intermodulation products at  $f_1 - f_2$  and at  $f_1 + f_2$  (100kHz and 400.1MHz respectively, in this example). Three initial frequencies create eight intermodulation products in total, and with four and more initial frequencies the situation is even more complex. In some circumstances, intermodulation products can have high enough levels to cause 'direct' interference, as for RF noise described earlier. Intermodulation products can also fall into the passbands of audio and video signals, and instrumentation circuits, reducing the quality of the output or leading to false measurements.

EN 61000-4-6 only applies one RF test frequency at a time, so can fail to discover susceptibilities that can occur in real life due to intermodulation. Real-life environments usually have significant levels at more than one radio frequency,

**Transposition via non-linear function resulting in d.c. offset (more commonly known 'audio rectification' of 'demodulation')**

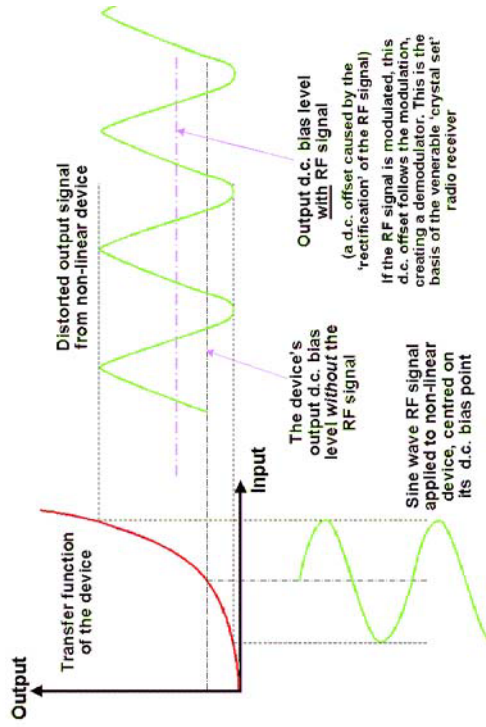

**Example of RF noise in a semiconductor circuit showing demodulation and intermodulation**

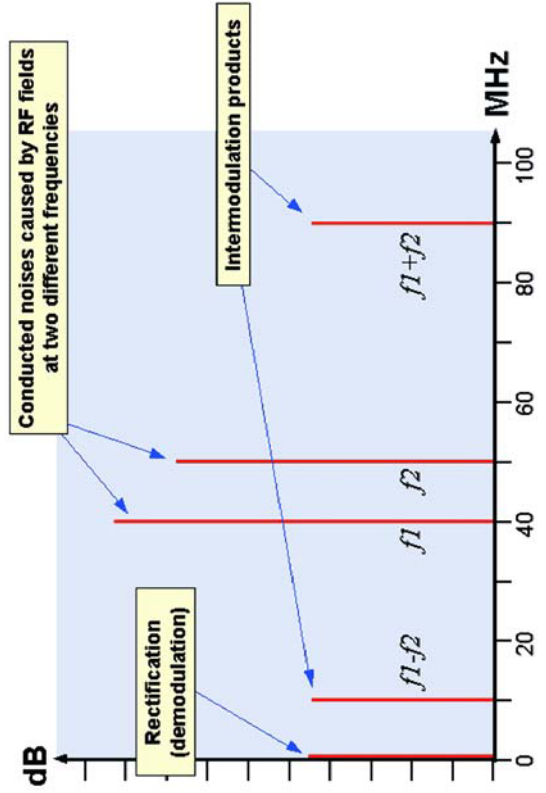

for example the very numerous AM and short-wave broadcasting stations. An item of equipment that is susceptible to RF noise, for example at 10MHz, will probably be well-protected by its designers against this frequency. But if it is exposed to two simultaneous RF noises at other frequencies (e.g. 1.8 and 1.81GHz) that it is not well-protected against because it is not susceptible to those frequencies individually (or because they were not tested, so susceptibility to them was unknown), the equipment might fail due to the 10MHz noise generated by the intermodulation in its own circuits.

All transistors are semiconductors, and are used in all analogue and digital integrated circuits as well as in discrete devices (e.g. power transistors). But many other types of devices are also semiconductors, for example: diodes, rectifiers, thermistors (NTC and PTC), and many types of overvoltage protection

devices. Adding transient voltage suppression to protect a chip connected to a cable from electrostatic discharge has sometimes increased the chip's susceptibility to radiated RF noise. Metalwork can also create 'unintentional semiconductors' when corrosion causes a film of oxide to form at joints. This can lead to some very unexpected real life problems due to demodulation or intermodulation; such as the Saturn launch vehicle safety concerns described in 'Banana Skin' No. 267 [7].

The levels of the noises caused by demodulation and intermodulation are usually assumed to be proportional to the square of the increase in the conducted RF noise level. This means that small variations in RF test level during testing can have a large difference on equipment functional performance, making it difficult to compare the results of different kinds of RF immunity tests.

**The three interference mechanisms**

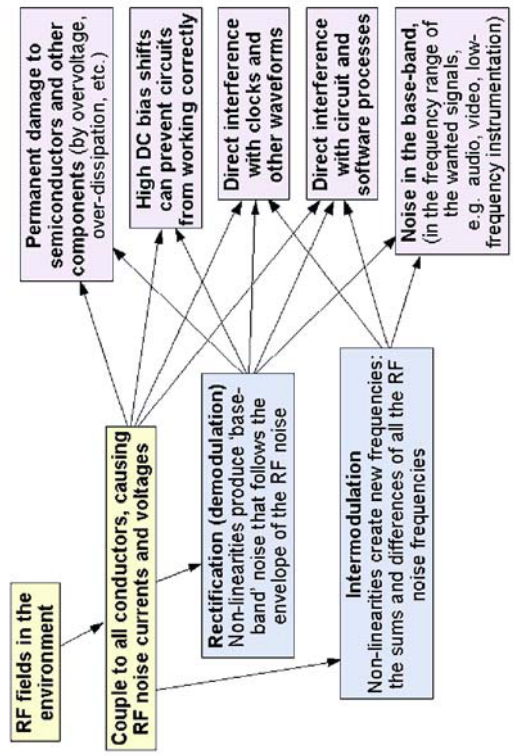

Since few, if any, real-life RF noises are modulated solely at 1kHz, the 1kHz modulation frequency used by EN 61000-4-6 is a poor test for real-life susceptibility or reliability. And, as was mentioned before, the use of a single RF test frequency cannot give rise to any intermodulation frequencies within the equipment, so it is also a poor test of real-life performance for that reason.

EN 61000-4-6 is usually used to test from 150kHz to 80MHz, but many types of equipment use circuits that operate at frequencies below 150kHz, and are consequently much more susceptible at those frequencies. Conducted noise under 150kHz can be caused by the switch-mode or phase-angle power converters; or when an RF signal at any frequency is modulated with frequencies below 150kHz (as most transmitted signals are), or when the presence of two or more different RF frequencies create intermodulation products below 150kHz.

One way to discover potential susceptibilities at frequencies below 150kHz is to test using EN 61000-4-16, which covers immunity from 0 to 150kHz (and will be covered by another REO booklet). Another way is to test equipment using a range of modulation frequencies for each RF frequency tested using EN 61000-4-6. The range of modulation frequencies should be chosen to cover the range over which the equipment concerned is susceptible. This method is mostly used by certain military and aerospace organisations for radiated RF testing at the time of writing, but is not yet commonplace.

A lack in EN 61000-4-6 is that it only injects common-mode RF and does not test differential-mode RF even though it can exist on mains and other types of cables. Differential-mode RF noise is mostly an issue at frequencies under 10MHz, especially when switch-mode power converters and other 'noisy' technologies are powered from the same mains distribution as the product concerned. However, it is possible to vary some of the test methods described here to test for differential-mode immunity.

There are military and automotive industry EMC immunity standards exist which test more aggressively and/or more thoroughly than EN 61000-4-6. Using such standards, or extending and toughening tests under EN 61000-4-6, can help produce more reliable products. One of the problems with warranty claims and field service is the 'no-fault-found situation'. Manufacturers spend money to try to keep their customers happy despite not knowing what the cause of the problem is. Many no-fault-found problems appear to be caused by inadequate immunity performance, but EMC problems are notoriously hard to repeat and anyway few service personnel are EMC experts or have any EMC testing gear.

The financial rewards of producing reliable products can be very great indeed, as one UK manufacturer discovered when they spent £100,000 on redesigning their products to comply with the new issues of the EMC Directive's immunity standards around mid-2001, and found to their complete surprise that their new products designs saved them £2.7 million in warranty costs *per year*.

But complying with any immunity test standards (even the ones used for flight control computers on civil airliners) does not necessarily ensure sufficient real-world reliability. This can be a problem for safety-related equipment and systems, or for equipment and systems that require very high reliability (such as speed cameras). For more on this issue, refer to the section on "Test As Real Life (TARL)" below, [10] and [11].

Continuous conducted RF immunity testing involves injecting RF voltages or currents into each of the cables associated with the equipment under test (EUT).

EN 61000-4-6 [2] is the basic EMC test method for common-mode conducted RF immunity called-up by the latest editions of harmonised product or generic immunity test standards. Alternative conducted test methods described here should always follow its methodology as far as is practical, to help make compliant products.

For small products, EN 61000-4-6 considers it acceptable to use its conducted tests over the range 150kHz to 230MHz, but for larger products the range is 150kHz to 80MHz. Small products with short cables may not need to be tested to as low a frequency as 150kHz. See Annex B of EN 61000-4-6 for more on frequency ranges versus EUT dimensions. But remember that it will be the relevant EMC harmonised standard (product or generic) that specifies the frequency range and test levels for a given type of EUT. In general, when self-declaring conformity to the EMC using the 'standards route' you will not be able to choose your own frequency ranges.

**Important Safety Note:** Even where the RF test levels used for conducted immunity testing are low, more intense fields may be present near RF power amplifiers and other equipment. People whose health depends on the correct operation of pacemakers or other body-worn or implanted electro-medical devices should never go near any EMC immunity tests or their associated test equipment.



There are five main issues in radiated RF immunity testing which are of concern for all the test methods discussed here:

- Injecting a reasonably accurate RF voltage (or current) into the EUT's cables.
- Preventing the tests from 'leaking' and possibly causing interference.
- The non-linear sensitivity of analogue and digital semiconductors to RF.
- Determining a reasonable 'engineering margin'.
- Monitoring the EUT to be able to tell when its performance has degraded too much.

It will help if we discuss these issues before moving on to describe the test methods themselves.

### Injecting a reasonably accurate RF voltage (or current)

EN 61000-4-6 describes how to perform a level-setting procedure (calibration) for each of the three types of test transducers it employs:

- Direct voltage injection using coupling-decoupling networks (CDNs).
- Induced voltage injection using the 'EM-Clamp'.
- Induced current injection using 'Bulk Current Injection' (BCI).

The level-setting procedures described in EN 61000-4-6 can be adapted for use with many of the alternative test methods described here.

### Preventing leakage

When RF voltages or currents are injected onto cables, the cables can act as antennas and re-radiate (leak) them. The CDNs and EM-Clamp transducers recommended by EN 61000-4-6 provide significant amounts of decoupling for the (usually long) length of the cable on their 'Ancillary Equipment' side, to prevent leakage from this part of the cables and also to protect the ancillary equipment.

With these two kinds of transducers, only the cables on their EUT side have high levels of RF on them, and they are short in any case and so are not usually very efficient antennae below 80MHz.

BCI transducers inject currents equally into the cables on both sides, so significant radiation is possible from the longer cables on the 'Ancillary Equipment' side. This leakage can be reduced by adding a large number of clip-on split-ferrite RF suppressors to the cable on the non-EUT side of the BCI transducer – close to the transducer. Usually a total length of ferrite of at least 200mm is enough.

Some experts recommend that conducted immunity tests are always done inside shielded rooms or shielded tents (no need for any RF absorber if the enclosure is room-sized) to prevent leakage from the cables / EUT from causing interference problems; whilst others seem to find that leakage is low enough not to need a shielded room.

Perhaps the best approach, if a shielded room is not available, is to consider whether there are sensitive electronics or radio receiver antennas near to where the test is to be conducted; whether the

conducted testing is going to use high levels of stimulus (e.g. for 'industrial' equipment); and whether frequencies above 80MHz are going to be applied to large EUTs, or above 230MHz to any size of EUT. If any of these are true it would be best to do these conducted tests inside a shielded room or shielded tent. Tents have the advantage that they are easily movable and can be packed away when not in use.

### Determining an 'engineering margin'

Even having EN 61000-4-6 fully applied by accredited test laboratories cannot guarantee that a given EUT and its cables will be exposed to exactly the same RF stimuli (say, within  $\pm 3\text{dB}$ ) each time it is tested. So, because of the non-linear sensitivity of analogue and digital circuits to RF and because serially-manufactured products have variable immunity performance due to component and assembly tolerances (often uncontrolled for EMC), an 'engineering margin' is recommended.

When testing an example product to EN 61000-4-6 in a fully compliant manner, at least a 6dB higher test level (e.g. 6Vrms instead of 3Vrms) is suggested, with the product still meeting its required functional specifications. Where there are significant differences in the test method compared with EN 61000-4-6, a much larger engineering margin is recommended.

It is clear that saving costs by using alternative conducted RF immunity test methods can lead to over-engineering. The additional cost to make the product pass the alternative test method with the necessary engineering margins should be weighed against the cost of doing the testing properly.

### The need for engineering margins

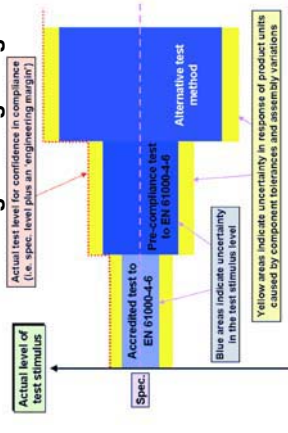

### Exercising the EUT during the tests

The EUT should be operated as near as possible to how it will be used in real life, with all the necessary auxiliary equipment (AE) connected, or simulated in a way that preserves their EMC effects. Some AE may need to be located outside the test chamber to help protect it from the EMC testing, so test planning should have determined how the signals or power are to be communicated between it and the EUT without compromising either the test of the EUT or the AE.

The EUT should be loaded as for normal operation, and where it is impractical to operate the actual load in the test lab this may require special load devices to be created.

Where the EUT performs any measurement or control functions, errors due to interference can cause an increase or decrease – so during the test the operational mode should be set so that all relevant signals are somewhere around mid-scale (or at least, not at the ends of their ranges). This allows any error to be detected.

Data signals should be sending a complex code, not just a string of 1's or 0's, and the

code should be checked for correctness in an appropriate way. When testing data communications it is common to employ a Bit Error Rate (BER) Tester, but where very high BERs are part of the specification testing can take a very long time unless alternative methods can be devised.

Displays should be continually changing, or at least have a changing portion, such as a winking icon. Lamps, LEDs and other on/off types of indicators should be continually flashing with a constant mark/space ratio or a repetitive pattern. For an alphanumeric display such as a 7-segment type, the pattern should exercise all of the portions of the display to detect any 'stuck' control bits. On an EUT with numerous indicators the result can be very pretty! Luckily, the human eye is very adept at spotting tiny changes in complex repetitive patterns, so the speed of operation of such patterns can be much higher than is often assumed, helping to reduce test time and cost.

'Digital' (i.e. on/off) functions should be switching off and on continuously, with a constant mark/space ratio.

All this may require special software writing just for the test, and/or special equipment made to exercise inputs appropriately. Care should be taken (especially with the software) to avoid altering any EMC characteristics of the EUT.

When testing using EN 61000-4-6 or similar test methods, the tested frequency range is covered in a number of small steps. At each step there is a 'dwell period' whilst the EUT is checked for performance degradation. To help keep test time short and costs low, the repetition rate of the various displays and on/off functions should be fast enough to detect an error in a reasonable time – preferably in a small number of seconds.

For 'on/off' functions, an alternative is to run the test with the EUT in the 'don't operate' condition (e.g. checking that the alarm does not sound at any time), then run the test a second time with the EUT in the 'must operate' condition (e.g. checking that the alarm does sound all the time).

But this is not as thorough a test of hardware and software as checking on/off cycling with correct mark/space ratio *throughout* an immunity test, so may not be appropriate where good reliability is required.

### Monitoring the EUT for performance degradation

The functional performance degradation allowed during and after conducted RF immunity tests may be specified by product-family standards (e.g. EN 55024), but if applying the generic standards EN 61000-6-1 or EN 61000-6-2 all that is necessary is that the performance is no worse than the specification in the manufacturer's 'data sheet' for the product – which should represent what its users would find acceptable given the marketing claims for the product.

Thought should be given to how the functional performance of the product is to be tested, especially if it is to be tested in a shielded room with no observers inside. Where performance can be assessed visually (e.g. screens and other displays, LEDs and lamps) it is usually checked by careful positioning of one or more shielded video cameras relaying their view to monitors outside the test chamber. It may require several people to watch all of the functional features on all of the monitors whilst the test is progressing, to avoid long dwell times at each frequency.

Where the signals on an existing cable need to be monitored, the cable should be

passed through the bulkhead connectors provided in the test chamber's connector panel and tested by external instrumentation. It is sometimes found that the external equipment is susceptible to the RF test signals that remain on the cables after passing through the chamber wall, or to the RF fields in the test laboratory caused by the powerful RF amplifiers used for the test. So whenever a performance failure is observed, it should be checked that it is due to a failure in the EUT and not in the equipment used to test it. This is often the case for sensitive instrumentation (e.g. noise and distortion analysers, oscilloscopes, etc.) and for external personal computers connected to the EUT using USB or Firewire.

Unshielded cables should be passed through filtered bulkhead connectors, and this can cause problems for high-frequency data (e.g. Ethernet) that uses unshielded twisted-pair cables. Special techniques may be required to deal with such problems, and most accredited test laboratories should have the necessary knowledge and experience.

Where there are other aspects of the equipment's functional performance that need to be tested during the immunity test, it may be necessary to place test equipment in the test chamber with the EUT (e.g. measuring motor speed with a tachometer) or to monitor various signals inside the EUT. It is important that these do not disturb the electromagnetic environment around the EUT, or alter the EUT's response. Given the very high frequencies used for these tests, connecting extra wires to parts of the EUT will alter its response, so this is not advised. There are suppliers of special signal monitoring equipment for this

purpose, for instance very small electrical-to-optical converters that have minimal effect on the EUT's circuits and their RF susceptibility, and communicate to monitoring equipment outside the chamber using fibre-optics.

Where an EUT has a function that has a long time-constant, dwelling at each frequency step for long enough to detect a change can make an EN 61000-4-6 test too lengthy (and costly). It may be possible to modify the response time of the function just for the test, but of course this must be done in such a way as not to alter the EMC characteristics of the EUT. Alternatively, it is often possible to measure other parameters of the EUT that indicate that the function would change if it was given enough time. For instance, when testing an EUT intended to maintain a volume of liquid at a constant temperature, the obvious method is to place a thermometer in the liquid and monitor it during the test – but due to the thermal inertia of the liquid it might be necessary to dwell for several minutes at each frequency step to be sure of detecting a change.

Alternatively, we might note that with the liquid held at a constant mid-scale temperature the mains current requirement of its heater is constant, so all we have to do is monitor the mains current to see if it increases or decreases at each frequency step. Typically, such temperature control systems have an electronic time-constant of around 1 second, so the dwell time at each step frequency can be reduced to at least 1 second making a huge reduction in the test time. Many other examples could be given.

A number of alternative conducted RF immunity test transducers and methods can be used. The use of close-field and 'pin' probes can be helpful for testing in design and development, fault finding, and QA but are not described here, see [12] and [13] instead for more on these.

For all but compliance and 'pre-compliance' tests, using an uncalibrated test for which the quantitative measurement is not traceable to the national physical standards is not very important. But it is very important for any tests to be repeatable – so consistency is always required in the test equipment and test methodology.

When doing remedial work after an immunity test failure, you will know which frequencies the EUT fails at and can test at only those frequencies to find the problem areas most quickly. However, when you make any changes to fix the known immunity problems you then need to test over the full frequency range, in case all you have done is 're-tuned' the problems so they appear at different frequencies.

During design or development testing, always try to reproduce the final assembly of the circuit being tested (shielding, earth bonding, proximity to metal objects or structures, etc.), as the stray inductances and capacitances in the final build state can have a dominant effect on the RF behaviour of the circuit. And always carefully record all the details of the test set-up in the test documentation (photographs can be very useful).

## Bulk Current Injection (BCI)

BCI is a useful test method as it is easy to clamp its current-injection transducers (essentially simple RF current transformers with split and hinged cores) over the cables to be tested. It is a favourite technique in the aerospace, military and automotive industries, and appears as a formal test method in some of their EMC standards (e.g. DO160 for civil aircraft, DEF STAN 59-41 Part 3 test DCS02, available from <http://www.dstan.mod.uk/home.htm> for military equipment; SAE J1113-4 and ISO 11452-4:1995 for motor vehicles). It is also an alternative test method in EN 61000-4-6, and its use for full compliance testing to this standard is described later.

The 'traditional' BCI test method uses a current injection clamp (essentially a clip-on current transformer) to induce a current in the cable being tested, while a second current clamp monitors the injected RF current and sends a signal to the feedback control circuit of the signal generator or power amplifier to ensure that the specified current is injected regardless of the cable's RF impedance. This type of RF level control is often called a 'levelling loop'. A wide range of current clamps exist, and can be hired if they are not needed often enough to justify buying them.

The current clamps are usually attached to the cables as close to the point where they enter the EUT as possible, so that cable losses do not attenuate the higher frequencies before they get to the EUT's circuits.

The typical use of BCI is to inject a common-mode current into a cable or cable bundle to simulate an illuminating RF field, but it can also be used on

## The 'traditional' BCI test method

Manual control shown, computer control is an alternative

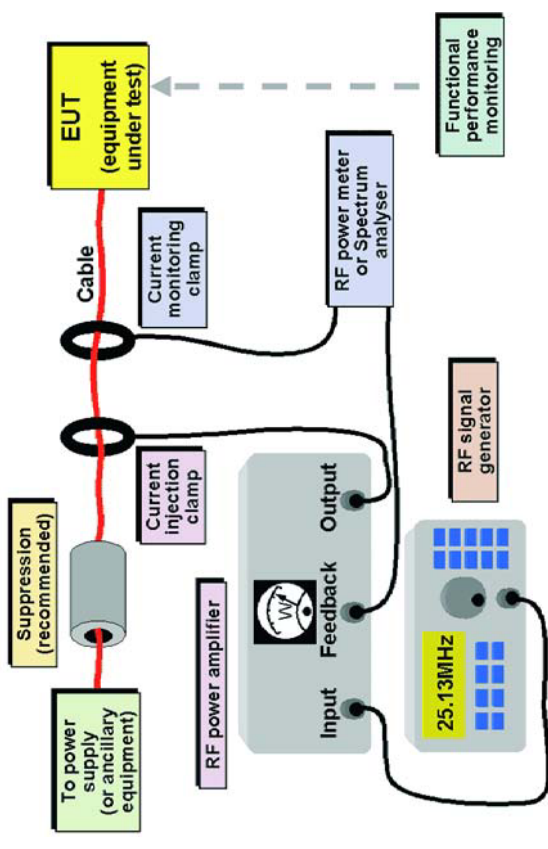

BCI testing a cable bundle  
(courtesy of the Rover Advanced Technology Centre, Warwick University)

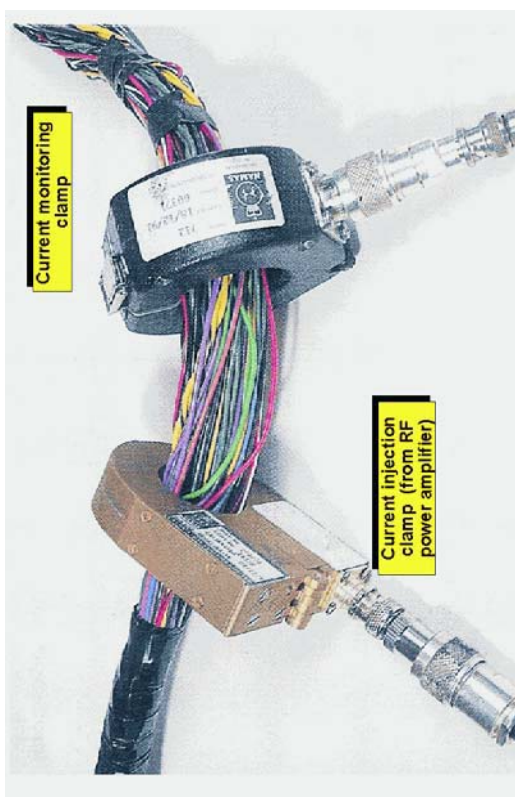

individual conductors within a cable or a bundle to simulate conducted differential-mode disturbances; for example from other electronic units connected to the same conductors. This can be very useful for developing the conducted RF emissions specification for, say, a new switch-mode power converter that is to share the same AC or DC power distribution as existing instrumentation.

When BCI is used to test cables **external** to an EUT, as an alternative to radiated field testing of the EUT, for simplicity's sake we assume that the common-mode impedance of the cables is  $150\Omega$ . Then we can convert the V/m field strength into Amps rms of injected current by merely dividing the V/m by 150. The conversion factor is thus 6 to 7mA/V/m. So 3V/m is considered to be equivalent to between 18 and 21mA rms of injected RF current.

The assumption of  $150\Omega$  common-mode RF impedance may not be true where there are cable resonances, when the impedance can become very high, or very low. BCI testing with a levelling loop can be fooled by cable resonances – high-impedance resonances cause the RF power amplifier's output voltage to rise to try to achieve the set test current, possibly requiring a very powerful amplifier to avoid clipping of the waveform. This situation is unrealistic of most real life electromagnetic environments, so could create a severe over-test situation.

Because the levelling loop forces a constant current, regardless of cable impedance, a low-impedance cable resonance can cause the test current to be lower than it would be in real life, possibly leading to undertesting. Where BCI is used to simulate differential-mode conducted disturbances, such as switch-mode converters operating from the same

mains supply (instead of simulating the effects of external fields) the actual source impedance of the 'noise' can be very low indeed, especially at frequencies below 1MHz, so the current injected into a low-impedance resonance can be very high. This needs to be considered when planning the test, and suitably powerful RF amplifiers and BCI transducers obtained.

EN 61000-4-6 and DEF STAN 59-41

DCS02 attempt to get around these 'traditional BCI' overtest/undertest problems by using a substitution method to set the RF drive levels, and by doing away with the levelling loop. A record is kept of the drive voltages needed at the various test frequencies to inject the desired test current into a short (non-resonant) cable terminated in  $50\Omega$  (a calibration piece). The drive voltages associated with each test frequency are then simply 'played back' into the actual cable to be tested without using a levelling loop. More detail on using BCI for compliance testing is provided later in this guide.

Of course, the substitution method means that the actual currents in the tested cables can vary considerably from those originally generated in the calibration piece, but this test method is less likely to over-test and is arguably more representative of real-life exposure to RF fields. But even when using the substitution method, overtest is possible at some cable resonances. The usual way to deal with this is to use the monitoring probe to keep an eye on the actual currents that are injected during the test, and, if they increase by more than a certain amount, to reduce the level of the drive signal accordingly over the problem frequency range. The substitution BCI test method is also similar to the EN 61000-4-3

### Calibrating, when using the substitution test method for BCI

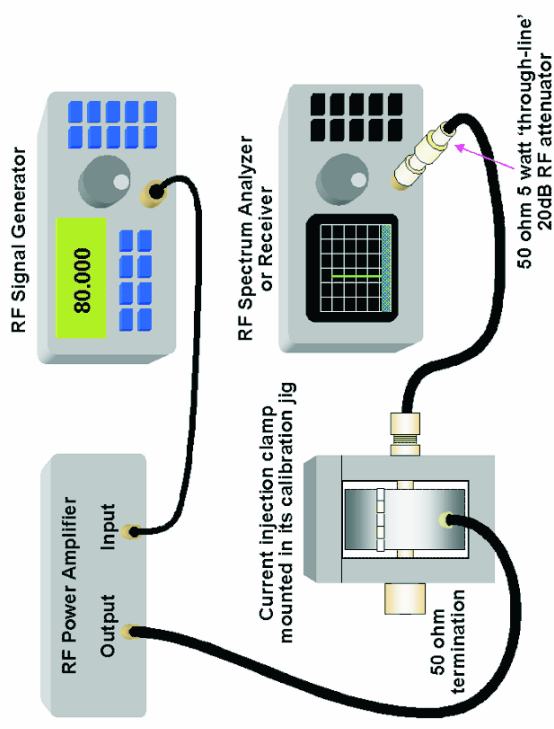

### Testing, when using the substitution test method for BCI

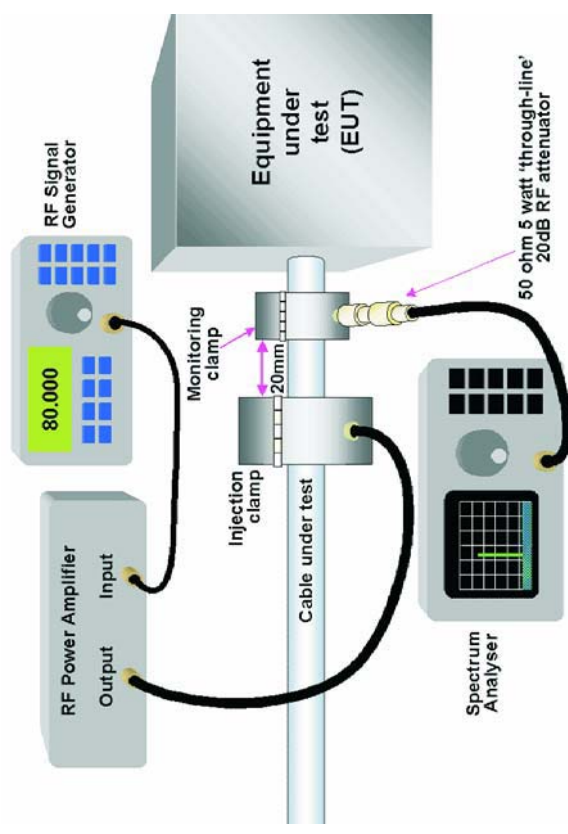

### Procedure for controlling the test level whilst using the substitution test method for BCI

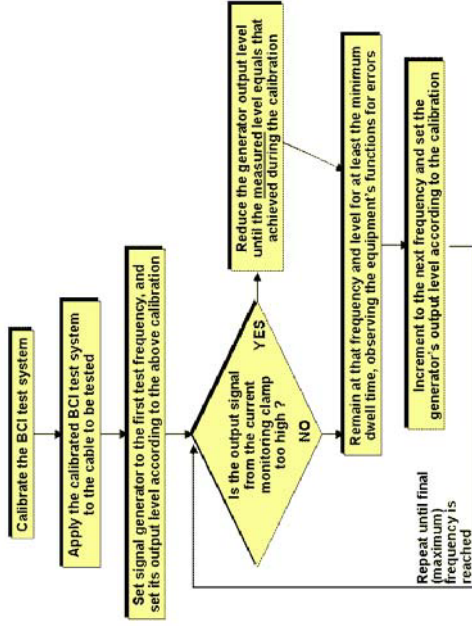

method used for compliance testing for radiated fields, and this will help give confidence when BCI is used as an alternative to radiated field testing (e.g. for the on-site testing of large installations).

When doing compliance-related tests some labs have been known to make the error of using a levelling loop instead of the substitution method, despite EN 61000-4-6 being quite clear on this point. Since the CE marking of a product is always the sole responsibility of its manufacturer (and never the test lab that they used), it is always a good idea to check that your test lab employs the correct methods.

If using BCI to simulate differential-mode conducted disturbances from equipment sharing the same mains supply (for example), the substitution method as described above (and later in this guide) may need to be modified accordingly, and it may be that the levelling loop method is more appropriate. Such tests are not

required for compliance (yet) so there are no standard methods.

One problem with BCI is that it has no directionality – so it tests the ancillary equipment required to exercise the EUT as much as it tests the EUT itself. Where the ancillary equipment is susceptible it can be protected to some degree by fixing a 200mm or more length of clip-on ferrite suppressor to the ancillary equipment side of the BCI injection transducer. Doing the BCI testing inside a shielded room and placing the ancillary equipment outside the room, running the interconnections through filtered bulkhead connectors in the wall of the room, is a good way to protect the ancillary equipment. But unless special 150Ω 'chamber exit filters' are used [14], these will dramatically alter the common-mode impedance of the cable being tested and could make the test unrepresentative.

Despite the problems of using conducted test methods to simulate radiated field

exposure at frequencies above 100MHz (see later), BCI methods are often employed up to 400MHz – even for large products – where radiated testing is not feasible (e.g. for on-site radiated immunity testing). When cables are energised with RF they have fields associated with them and these will search out weaknesses in the EUT itself; although in a fairly uncontrolled manner. To use BCI up to 400MHz with any degree of repeatability it is important to ensure that the cable under test always sits in exactly the centre of the current transducer,

ideally with a proper centring device but if not by packing the transducer with flexible foam plastic. Repeatability of the set-up, especially cable routing, placement of the clamps, and proximity to metal structures is also very important. Bear in mind that at this frequency the half wavelength is 375mm – the impedance of a resonating cable passes from minimum to maximum through this distance.

Injecting substantial amounts of RF power into typical BCI clamps can cause them to get very hot and even be damaged. A ferrite-free BCI clamp was developed by DRA (now Qinetiq) to handle high powers from 10kHz to at least 400MHz with less heating.

However, [15] reveals that BCI testing is subject to a number of quite large uncertainties, whereas a similar method using an EM-Clamp provides more predictable results, can be used up to 1GHz, and requires much less powerful RF power amplifiers for the same levels of injected RF current. So it would seem that the only advantage of BCI testing is that the BCI transducers are smaller than the EM-Clamp and easier to fit into confined spaces, which can be important for on-site testing.

### The EM-Clamp

Like BCI, the EM-Clamp transducer is an alternative test method in EN 61000-4-6. It induces RF voltages into cables using a combination of inductive and capacitive coupling, and its application is similar to the BCI substitution method. Using the EM-Clamp test for full compliance testing to EN 61000-4-6 is described in detail later.

#### Example of an EM-clamp shown in the open position ready to accept cables



The original model of EM-Clamp was specified for use at up to 100Vrms from 150kHz to 1000MHz so can be used as an alternative to radiated test methods, for example for development or QA testing, or the on-site testing of large systems. If it is intended to use an EM-Clamp for such high test levels or high frequencies, it would be as well to check that it meets the original Swiss PTT specification and has not been 'value engineered' so that it is only suitable for testing at up to 80 or 230MHz, or at levels only up to 10Vrms.

New EM-Clamps can cost over £2,000, but EN 61000-4-6 may give enough constructional detail to allow keen EMC engineers who are good with their hands to build their own and save quite a bit of money (if they don't count the cost of their own time).

Similar comments to those above about the use of the substitution method in compliance-related testing to EN 61000-4-6 apply to the use of the EM-Clamp as well as to BCI and CDNs.

## Direct injection with a CDN

EN 61000-4-6 specifies the use of coupling-decoupling networks (CDNs) that directly inject RF voltages into the cables under test. The CDN method is described in great detail in EN 61000-4-6 and later in this handbook. Typical CDNs cost in the order of £500 each, but it is very easy to build your own CDN that works well up to 230MHz using the guidance in EN 61000-4-6.

CDNs, like all transducers, need calibrating, but if you have calibrated RF emissions measuring equipment it is easy to do yourself using the method described in EN 61000-4-6. They can also be calibrated easily using an oscilloscope which has a bandwidth at least 50% higher. It can be tricky to figure out the voltages you should see on your spectrum analyser or oscilloscope when using the calibration technique from EN 61000-4-6, so take great care to understand what is going on.

Don't forget that CDNs handle several watts of RF power, so make sure their resistors are rated accordingly. Most people who build CDNs are familiar with the smell of burning resistors. Many EMC test engineers are also familiar with burning resistor smells because they may be using RF power amplifiers which are more powerful than required for the conducted immunity testing. Accidentally setting the output power to full on such an amplifier can rapidly burn out a CDN.

CDNs can be used at higher frequencies than EN 61000-4-6 as an alternative to radiated test methods – for example for development or QA testing, or the on-site testing of large systems. Most commercial CDNs are only specified for use up to 80MHz, although some are specified at up

to 230MHz. Richard Marshall Ltd manufacture a 'Versatile CDN' that can be used for shielded or unshielded cables from one to a number of conductors, and is also specified for use up to 500MHz [16], [17].

For the same stress level, the IEC standards use the same voltage for conducted testing as the field strength in V/m for radiated. However, the conducted test level is specified as Volts emf, which is the voltage applied into an open circuit load; the actual voltage applied from 150Ω into the EUT's common mode impedance is less.

Remember that V/m are specified when unmodulated, as are Vrms for conducted immunity tests; however, the actual radiated or conducted immunity tests should use modulated fields or waveforms (1kHz at 80% amplitude modulation depth preferred) which will have a higher peak level and may measure a different rms voltage.

Similar comments to those above on BCI, about the use of the substitution method when doing compliance-related testing using EN 61000-4-6, apply to the use of CDNs as well.

## A home-made CDN-M3 (for L, N, E three-wire mains and similar high-voltage cables)

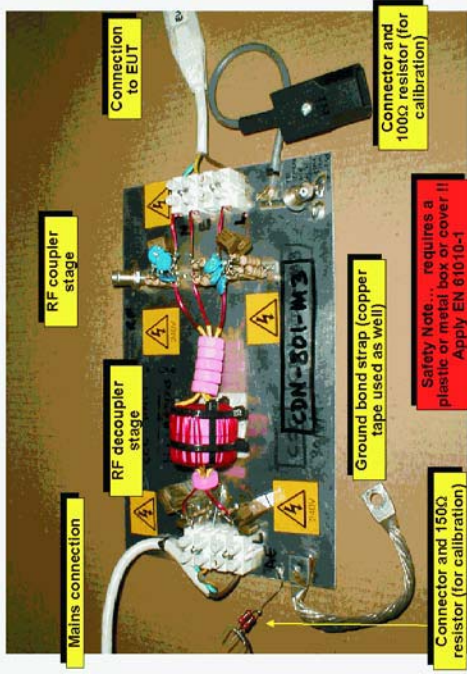

## A Typical CDN



For conducted immunity tests to be repeatable, test set-ups must be carefully controlled with, wherever possible, all the cables associated with the EUT and the EUT itself mounted at a set height (often 100mm) above a ground reference plane that lies under the EUT and extends beyond it by at least 200mm.

The terminations at the other ends of the cables from the EUT should either be to a coupling/decoupling network or to the specified ancillary equipment, or else be terminated to the ground reference plane in a controlled manner representative of the intended use of the EUT (a 150Ω common-mode resistance is often specified).

CDNs are relatively expensive items to buy, given the number of different types that a test lab may need to cover the majority of its customer's products. Although the CDN is the preferred transducer in EN 61000-4-6, some test labs may prefer to use an EM-Clamp or BCI to avoid the need to stock dozens of types of CDNs. The results from using each type of transducer on the same EUT will be different, hence different labs may find they get different results [18].

There is a need to correctly terminate the RF outputs of most types of RF power amplifiers, apart from those which have been specifically designed to work with unmatched loads. CDNs built according to EN 61000-4-6 include a series impedance of 100Ω and other types of transducers may have non-50Ω impedances which can cause a 'frequency ripple' related to the length of their cable from the (50Ω output impedance) RF power amplifier. The reflections at the mismatched load termination are the problem, and they are usually dealt with by connecting a 50Ω through-line 6dB attenuator in series with the RF drive very close to the transducer. A further important reason for this attenuator is to ensure that

the drive impedance seen by the CDN remains close to 50Ω, so that the test source impedance of 150Ω is maintained.

#### A 20W 50Ω through-line 6dB attenuator

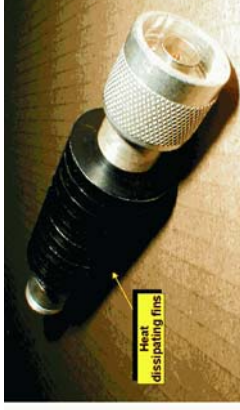

The output power rating of the RF power amplifier needs to be increased to include the losses in the attenuator. It is also best to rate the through-line attenuator for the maximum power output of the amplifier to avoid the possibility of damaging it by over-dissipation.

Because the EUT is not bonded to the ground reference plane during conducted RF tests, the signals that are injected into one cable tend to 'leak out' via other cables. Thus, testing just one cable port (e.g. the mains) tends to reveal the weaknesses in all the other cable ports. This is a very useful feature that can save a great deal of time when using conducted RF testing for design/development, troubleshooting or QA purposes.

Where a shielded cable is used, it is normal to inject the conducted voltage or current onto just the shield. However, if the shield is not terminated at the EUT (as might happen when following some single-ended shield terminating installation techniques) it may simulate the real-life environment better to inject the RF directly into the cable's inner conductors and ignore the unterminated shield. For BCI and EM-Clamp injection this may mean preparing a special cable, while for CDN injection it will mean using a model which uses an unshielded cable.

the probe, reset the frequency, physically scan again, and so on – which can be very time consuming.

The tracking generators sometimes included with spectrum analysers can also be used as sweep signal generators for conducted immunity testing, but unfortunately they don't have a modulation feature. For some types of products (e.g. pure digital products with digital I/Os) modulation might not be crucial, so simply increasing the test level by 80% might allow the use of a tracking generator. However, for most types of products, especially those with analogue functions, an external RF modulator would be needed. Rather than use sine-wave modulation, the much simpler technique of on/off switching the RF carrier at a 1kHz rate should be simpler to arrange, remembering to increase the RF level by 80% first.

An alternative to sweeping or stepping the frequency is to use a broadband noise generator, such as the RF 'comb' generators or random noise sources used in Comparison Noise Emitters (CNEs) or equivalent available from a number of manufacturers. CNEs (or equivalent) are usually sold for characterising emissions test sites, and although their output spectrum may not be very 'flat', they are very repeatable.

Comb generators can be fairly readily designed and assembled. For a 100MHz top frequency they would typically pass a square-wave of between 100kHz and 1MHz through a very fast switching device to generate a very broad band of harmonics of the basic switching rate. The maximum rise and fall times ( $t$ ) of the fast switcher set the top frequency ( $f$ ) of the comb, according to the rule-of-thumb:  $f = 1/\pi t$ . So, for example, rise/fall times of 3ns are needed for an upper frequency approaching 100MHz. Note that achieving rise/fall times of 3ns or

### Alternative types of signal generator

Compliant testing using EN 61000-4-6 specifies an RF signal generator that increments its frequency according to specified rules for step size and dwell time at each step. It might be tempting – for low-cost testing, and testing in design/development, fault-finding, or production QA – to just use a simple RF signal generator with manual tuning. But the temptation to save money at all costs should be tempered by consideration of the testing time required. For some kinds of tests, especially close-field probing, covering the frequency range from 150kHz to 80MHz (or more) with a manually-tuned signal generator could take so long to do that it would be a false economy.

Happily, most of the RF signal generators manufactured over the last 20 years have a useful degree of automation – even the low cost ones feature automatic analogue sweeping (or digital synthesiser 'stepping') between two frequencies, plus a variety of useful modulation waveforms. Old Marconi 2022s and the like usually have all the features required to minimise testing time. They can now often be found at very reasonable prices in second-hand electronic equipment or radio amateur shops.

It is especially useful to use a signal generator that 'sweeps' or 'steps' automatically over the whole frequency range of interest. When close-field probing, the sweep rate should be fast enough so that several sweeps occur for each position of the probe, but not so fast that the circuit can't respond in time to a particular problem frequency. The alternative procedure for a manually-tuned generator is to set the signal generator to one frequency, physically scan the EUT with

less with a 5V signal swing requires attention to detail – RF design and assembly techniques will be needed.

It is difficult to get a comb generator to have a high level of signal at a high frequency due to the natural roll-off of the amplitude of the harmonics at 20dB/decade according to the Fourier series for a square wave. A single-pole high-pass filter after the fast switcher will help compensate for this to create a flatter frequency/amplitude characteristic, but it does this by attenuating the lower-frequencies. For example, with a 1MHz switching rate if a level of 1Vrms is required at 100MHz then either the fast switcher must run from around 100V or the high-pass filter must be followed by an RF power amplifier. If the fast switcher was running from a 5V rail, the RF amplifier would need a gain of about 30dB.

**Block diagram of a comb generator**

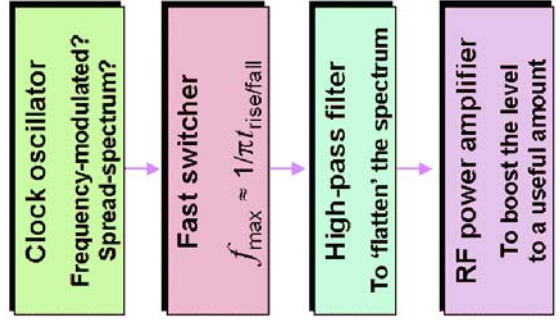

There is a trade-off between the spacing of the frequencies in the comb and the RF amplifier gain or fundamental switching voltage. To keep the design simple and avoid high-voltage switching or high-gain RF amplification it may be best to use a number of switching rates (e.g. 10kHz, 100kHz and 1MHz) to cover different frequency ranges (e.g. 100kHz-1MHz, 1-10MHz and 10-100MHz respectively). The comb spacing that these provide will be adequate for many applications, but to be more thorough requires filling in the gaps between the comb's 'teeth' by, for instance, modulating the switching frequency by ±6%. It may be possible to use one of the increasingly popular spread-spectrum clock generators instead, if they can spread the clock frequency by this large a percentage.

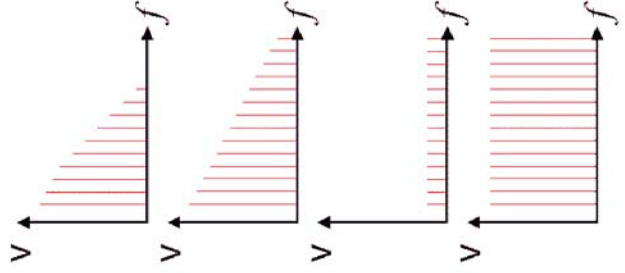

so a 45 or 50W amplifier may be necessary for testing industrial products to EN 61000-4-6 using CDNs.

Other types of transducers to the CDNs described in EN 61000-4-6 are less efficient. The EM-Clamp typically requires three to four times the RF power of a CDN for the same actual test level. BCI clamps, because of their higher losses, are even less efficient.

A problem with high-power amplifiers is that the transducers and any termination resistors or through-line attenuators should be rated to take the full power of the amplifier. Most proprietary CDNs may not be rated for much higher powers than the 10Vrms of the 'industrial' level immunity test, and they are expensive to replace unless you build your own.

The output from a CNE (or other noise generator) should be isolated from the load by passing it through a broadband RF amplifier which has enough power to drive a loop probe over the frequency range required. A filter could be fitted between the CNE's output and the amplifiers input to restrict the frequency range of the test, if required.

Even driving loop probes and current probes from a Fast Transient Burst generator will, to some degree, test over the frequency range covered by typical conducted immunity tests and may be a way to get extra value from equipment you already own.

**RF Power Amplifiers**

To test using EN 61000-4-6 and CDNs at the 3Vrms level required for residential, commercial, and light industrial environments may require a power amplifier rated at about 2-3W. For the 10Vrms industrial level power amplifiers of around 15-20W may be required (using CDNs).

Simple calculations based on the 150Ω impedance used by EN 61000-4-6 indicates much lower power levels, but usually forget the loss in the 6dB through-line attenuator and the nearly quadrupled power required to cope with the peaks of an 80% amplitude modulated RF waveform; plus the fact that the maximum output power rating of RF amplifiers is usually given for a certain degree of 'compression' – so we need to use an amplifier which is more powerful to achieve the peak test levels.

To overtest by 6dB (to give a good safety margin on an accurate compliance test) requires a four-fold increase in RF power,



When an alternative radiated RF immunity test method is used for design, development, or troubleshooting; after a test failure, repeatability is very important (even though the correlation with EN 61000-4-6 may not be). All such tests will need to follow a procedure which has been carefully worked out to help ensure that adequate repeatability is achieved.

When alternative methods are used as part of a QA programme, or to check variants, upgrades, or small modifications, a 'golden product' is recommended to act as some sort of a 'calibration' for the test equipment and test method. Golden product techniques allow low-cost EMC test gear and faster test methods to be used with much more confidence. Refer to section 1.9 of [12] for a detailed description of how to use the golden product correlation method.

If alternative methods are used to gain sufficient confidence for declaring compliance to the EMCD, the golden product method is very strongly recommended. Without a golden product or some similar basis for correlating a proper compliance test (using EN 61000-4-6) with the alternative method actually used, the alternative method can only give any confidence at all if gross levels of overtesting are applied, and this can result in very expensive products.

The closer a test method is to using the proper test transducers and methodology in EN 61000-4-6, the more likely it is that a good correlation will be achieved. So testing with a close-field probe (for example) can probably only be correlated on a particular build state of a specific product; while EM-Clamp testing using a pseudo-random noise source instead of the stepped frequency source may be able to be correlated for a range of products from one manufacturer sharing the same electronic technology and assembly/construction methods.

Section 10.2.5 of [19] describes the methods that have been developed for on-site testing for conducted immunity. These are not a great deal different from the three methods used by EN 61000-4-6, but BCI is often easier to employ on a site because it disturbs the cables less. However, [15] shows that if an EM-Clamp can be used instead of BCI, much more accuracy and repeatability will be achieved (and the size and cost of the RF power amplifiers used will be less).

One problem with on-site testing is that it may be impractical to arrange for a ground plane as specified by EN 61000-4-6 and as a consequence the parasitics, which can have a significant effect at the higher testing frequencies, might not be well controlled. Although this is often acceptable for a Technical Construction File for an individual apparatus, it is less satisfactory if used to predict the conducted immunity of the same or similar type of apparatus on a different site.

**Important Safety Note:** Don't forget that interference, especially with aircraft or other vehicular systems, some machinery or process control systems, and implanted electronic devices such as pacemakers, can have lethal consequences and appropriate precautions **must** be taken to make sure that nobody's safety is compromised. It is also a good idea to take precautions where there is a possibility of significant financial loss being caused by the interference from on-site testing.

Where radiated emissions from on-site conducted RF immunity testing could be significant (i.e. when the conductors injected into are longer than  $\lambda/10$  at the highest frequency tested) it may be necessary to shield the system being

tested with a shielded tent. Where there are no safety or financial loss implications of the radiated emissions from the tests and a shielding tent is not to be used, it may be necessary (for legal testing) to first obtain a special license from the National Radiocommunications Agency responsible [20], which is the UK is now OFCOM, [www.ofcom.org.uk](http://www.ofcom.org.uk).

EN/IEC 61000-4-6 defining tests for "immunity to conducted disturbances, induced by radio frequency fields" is a complex standard which is very easy to misinterpret. This section offers a simplified stroll through this minefield to highlight the principal requirements. If you are actually doing a full compliance test on anything other than a very simple EUT, you will almost certainly have to make some compromises and deviations from the letter of the standard. Understanding the rationale for some of the requirements will enable you to make an informed decision.

Test standards such as EN 61000-4-6 contain a great deal more detail than can be included in a guide like this, so when testing always make sure that a copy of the appropriate standard is at hand – and follow it.

### Generator

The basic requirement for the test system is to generate a modulated RF signal of sufficient amplitude, swept or stepped over the frequency range from 150kHz to 80MHz. The upper frequency range may be extended by some product standards to 230MHz. The system normally uses a standard GPIB-controlled signal generator feeding a broadband linear power amplifier of the required power level – Table 1 gives the necessary power levels for a 10V (level 3) test, depending on transducer. The standard modulation on the signal, as usual, is a 1kHz sinusoidal tone modulated at 80% depth.

The amplifier must be linear so that it does not distort the modulated waveform, and so that it does not introduce harmonics of the wanted stress frequency. The specification for harmonic amplitudes is

that they should be -15dBc, that is 15dB below the wanted frequency stress signal level, across the whole test range, whatever the load conditions on the amplifier.

The output of the amplifier could be coupled directly to the cable transducer, but as we shall see, the common-mode source impedance of the transducer is affected by the driving impedance, which should be 50Ω. To achieve an accurate common-mode impedance this 50Ω must be carefully controlled, but the amplifier's output impedance can vary quite widely. To deal with this, an attenuator of at least 6dB is required between the amplifier output and the transducer. Naturally, this means that three-quarters of the

amplifier's output power is lost in this attenuator before it reaches the transducer, so the amplifier must be sized for a four times greater power level than would be needed without the attenuator. This factor is allowed for in Table 1.

**Table 1 Required power levels (from IEC 61000-4-6 table E.1) for 10V emf**

Transducer type	Coupling factor	Required power output from amplifier
CDN	0dB	7W
BCI	-14dB	176W
EM-Clamp	-6dB	28W

### The RF test waveform is typically 80% amplitude modulated (AM) with a 1kHz sine wave

The EN 61000-4-6 test level is always specified for the unmodulated wave, so for example a 10V rms test has a peak-to-peak voltage of 50.9V

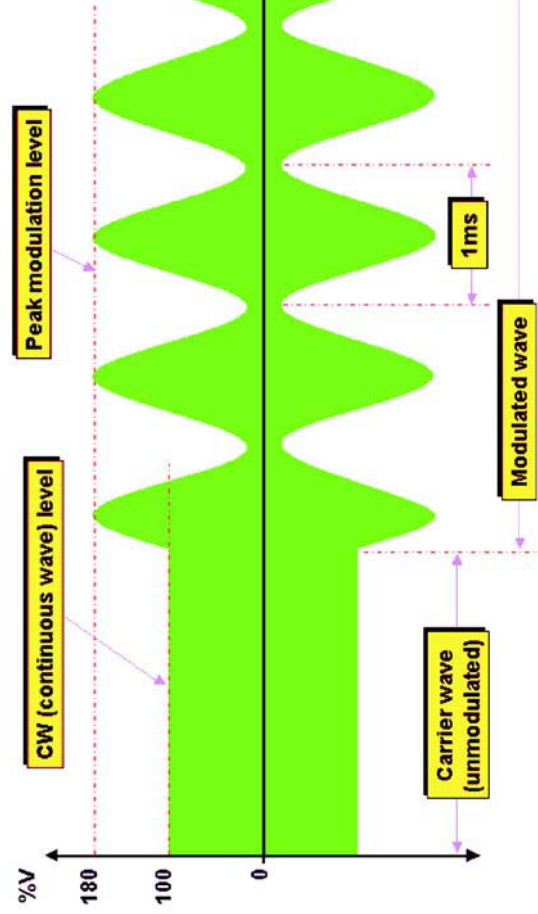

## Transducers

The standard allows three types of transducer: the coupling/decoupling network (CDN), the EM-Clamp and the current injection probe. It also allows direct injection, that is coupling directly onto the screen of screened cables via a resistor, but demands that a decoupling network is used in addition, and frequently these are combined into a CDN designed for particular screened cables.

As can be seen from Table 1, the CDN requires the least power and is also the most definitive method, since it automatically and accurately controls the injected source impedance (specified in Table 2) and the decoupling of the AE, that is, the cable end away from the EUT. Therefore the CDN is the preferred choice of transducer. Unfortunately, it also requires a specific type of network for each type of cable to be tested, since it needs a direct connection to each line in the cable.

Because CDNs are invasive, they may have a significant effect on the signals carried in the cable, particularly if these are broadband. For some types of cable, particularly mains and DC power, low frequency signals, audio telecom, and the more common types of screened cable, it is reasonable to have a variety of CDNs on the shelf which you can select for particular tests. If you are a product manufacturer and you know you will only be testing certain types of cable, you can carry CDNs just for these types, but this option isn't available to a general test house.

**Table 2 Common mode source impedance specification**

$Z_{CEI}$ with 50Ω at input port, AE port both open and short	0.15 – 26MHz	26 – 80MHz
	150Ω ±20Ω	150Ω +60Ω–45Ω

For cables for which CDNs are not "suitable" (and the interpretation of "suitable" is entirely up to the tester) two other non-invasive injection methods are provided. These use the EM-Clamp and the current injection probe. The EM-Clamp (described earlier) is specifically designed for this test and although it looks similar to the ferrite absorbing clamp ('total power clamp') used for some kinds of emissions tests, it is in fact quite different. It is described in Annex A of EN 61000-4-6.

The EM-Clamp is designed to give significant (better than 10dB at some frequencies) directivity, so that the AE end of the clamp is reasonably adequately decoupled. It requires no connection to the cable under test and is therefore popular for situations where many different types of cable must be tested, and it is also reasonably efficient, as Table 1 demonstrates. Even so, the common-mode impedance is not nearly so well controlled as in the CDN case, and the directivity and efficiency fall off at the lower frequencies.

The third method uses the BCI substitution method described earlier. BCI probes are convenient and easy to use, but inefficient compared to the other methods, need a higher power (and more expensive) amplifier, and provides absolutely no directivity or common-mode impedance setting. For this reason it should only be used if there is no alternative method.

Example of the EM-clamp test method

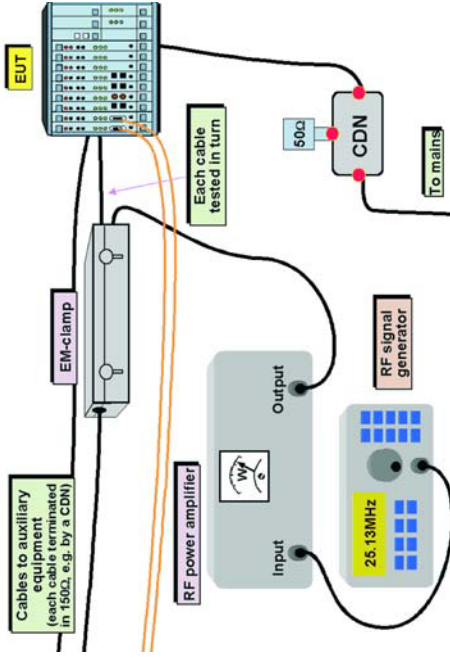

For both EM-Clamp and current probe methods, the standard points out that the AE is part of the test and should present the proper 150Ω common-mode impedance and be adequately immune. The first of these is not at all easy to ensure and the standard describes using a combination of decoupling networks (assemblies of wideband ferrite sleeves) and CDNs to achieve it. For complex or multiple AEs this becomes cumbersome or impractical and a modification of the test method involving an extra monitoring current probe is used.

Calibration and levels

The basis of the IEC 61000-4-6 test is that it uses a substitution method. That is, the stress is calibrated into a fixed impedance in the absence of the EUT, and then the same power level versus frequency is re-played into the EUT itself. This method avoids unwarranted peaks or nulls due to variations in the EUT's common-mode port impedance. However, it requires stability on the part of the generation system and transducers, and it also means that

variations between different transducers can contribute to the lack of reproducibility of the test. In other words, both the choice and quality of the transducer are critical to standardising the test between laboratories.

The same calibration set-up as for the CDN applies when calibrating the EM-Clamp, and a modification to it applies for the current injection probe. The CDN is terminated at both its AE and EUT ports – all wires shorted together – with a 150Ω load, and its input port is fed in exactly the same manner as it will be in the test proper. The EUT port load is made up of the measuring instrument's 50Ω input impedance plus a "150Ω to 50Ω adapter". This adapter is nothing more than a series 100Ω resistor. Although this resistor and associated connecting parts is obviously a very simple piece of apparatus, you should remember that its accuracy is fundamental to the accuracy of the set level, and make sure that it is maintained across the applicable frequency band and at the power levels applied.

Calibration of a CDN for EN61000-4-6 testing

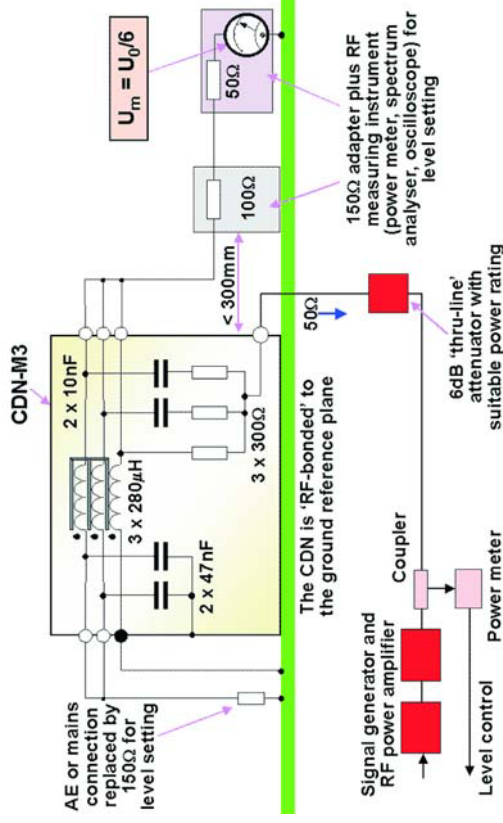

According to Table 1 of EN 61000-4-6, the standard test levels are:

- Test Level 1 1V rms
- Test Level 2 3V rms
- Test Level 3 10V rms
- Test Level X Special (unspecified)

Test Level X is called an 'open' specification. Basic test method standards cannot possibly deal with all eventualities, so the 'X' specification can be set by a product or generic standard committee if they feel it is more appropriate for the type of equipment covered by their standard. The 'X' levels can also be specified by a purchaser – usually in the technical specification that forms part of their contract with the manufacturer.

It is important to be aware that the test levels are specified as the voltage into an open circuit; not the voltage that is actually applied to the EUT, nor even that which is observed on the measuring instrument during calibration. Because both source

and load impedances are known during calibration the actual indicated voltage for an applied emf level can be calculated. For the CDN calibration jig, the source impedance is 150Ω, the load impedance is also 150Ω and the measuring instrument impedance is 50Ω. The indicated voltage must be multiplied by 3 to allow for the 50-to-150Ω conversion and again by 2 to reach the open-circuit voltage, hence the indicated value is 1/6<sup>th</sup> the desired stress level. The current probe calibration jig uses a 50Ω rather than 150Ω system and therefore the indicated value is half the stress level, since no 50-to-150Ω conversion takes place.

Once the power level for the required stress value has been established at each frequency then it is stored in software and re-played during the actual test. Modulation is not applied during calibration – the test levels are specified as the unmodulated voltage – but it is applied during the test. The standard allows level

setting to be applied at the output of the signal generator, but this of course assumes that the power amplifier is adequately linear and stable. Many test software suites use a coupler at the output of the power amplifier, and monitor and control on the measured output power. This negates any effects of gain drift in the amplifier. Either method is allowable.

This method is of course open-loop; there is no requirement to check the actual applied level during the test, although a prudent test facility may leave a monitoring device in place merely to confirm that nothing has broken. Because of the nature of the substitution method, the indication on this monitor bears no real relationship to the intended stress level.

But in the case where clamp injection is used and the 150Ω AE common-mode impedance is not achievable, clause 7.3 of the standard requires that the applied current is monitored during the test sweep, and limited if necessary to the value that would have been applied into a common-mode impedance of 150Ω, e.g. 66.7mA for a 10V emf level. This prevents over-testing in situations where the EUT common-mode impedance is substantially less than 150Ω. It doesn't, though, mean a 'levelling loop' type of test.

### Test set-up

The important aspects of the test set-up are to control the common-mode impedance presented by the transducers, the EUT and its AE, and to ensure that cable resonances are avoided. The first of these is achieved by having an adequate ground plane for the whole test area, and placing the EUT a defined distance (10cm) above this ground plane. The AE is also placed at this height if clamp injection is used. The ground plane is the reference

for the applied voltage and so the CDNs and EM-clamp must be fully bonded to it, preferably by direct bolted fixing. Since the test extends up to 80MHz, any inductance in this bond is unacceptable. The ground plane itself need not be externally grounded for EMC purposes, but it is advisable to connect it to the facility earth for safety.

Cable resonances are potentially serious: a distance of a ¼ wavelength transforms a short-circuit impedance into an open circuit, completely altering the coupling properties of the setup. A ¼ wavelength at 80MHz is 940mm and therefore no cables included in the test environment should approach this length, even if they are not being tested. The standard insists that on the tested cables, the coupling/decoupling devices should be between 100 and 300mm from the EUT and the cables themselves should be maintained 30-50mm above the ground plane, as short as possible and unbundled. When using the current injection probe, the cable length on the other side of the probe (the AE side) should also be less than 300mm.

If there are multiple cable ports on the EUT, only a limited number need be tested, exciting between 2 and 5 current paths through the EUT. The most sensitive configurations should be selected, although no guidance is given as to how to determine these. Other cables should be completely disconnected from the EUT, isolated with CDNs or decoupling networks (each providing a 150Ω common-mode impedance to the ground reference plane), or simply fitted with 150Ω common-mode terminations (e.g. join all the conductors together and connect them to the GRP via a 150Ω resistor). When several cables are loomed together in the normal installation, they

### Example of test set-up for EN 61000-4-6

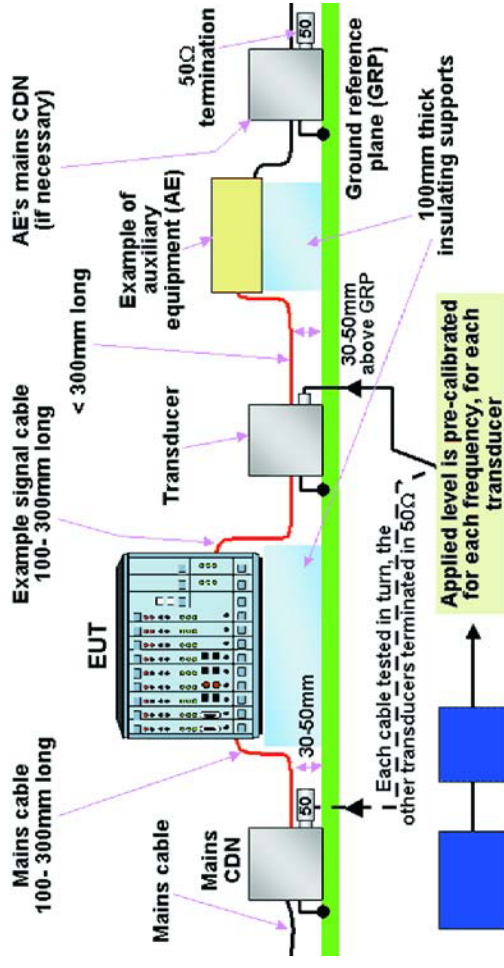

**RF signal generator plus power amplifier**  
A 50Ω 6dB thru-line attenuator is fitted at the transducer end of the RF cable (not shown here)

All cables to the EUT and AE are fitted with appropriate transducers (CDNs, EM-Clamps, or BCI clamps) or with decoupling networks. But mains cables must be fitted with CDNs.

can be treated as one cable for the purposes of testing. Separate earth ports on the EUT are treated like any other cable port and also tested, most easily with a one-line CDN (known as a CDN-M1).

When several cable ports are to be tested in turn, the ideal test set-up employs CDNs on each cable, each one terminated in 50Ω to provide a 150Ω CM termination for the cable. The CDN on the cable to be tested has its termination removed and the 6dB 'thru-line' attenuator attached instead, driven with RF from the amplified signal generator. Each cable is then tested in turn, with all the others terminated correctly.

Of course, EM-Clamps or current injection probes can be used instead of CDNs although as mentioned above it is harder

to control their CM impedance to the GRP. Note that EN 61000-4-6 insists on the use of CDNs for testing a.c. mains and d.c. power supply cable ports, for full compliance testing.

Hand-held devices and keyboards need to be tested with an artificial hand, which is a simple RC network simulating hand-to-ground impedance. EUTs consisting of several interconnected units should be tested by considering each sub-unit as an EUT in its own right, with all other parts treated as AE. But if the interconnecting cables will always be less than 1m they can be treated as internal and left untested, the component sub-units of the EUT being grouped together and close to each other on the 10cm insulating support, with only the "external" cables subject to testing.

### Example of a test set-up for testing multiple cable ports

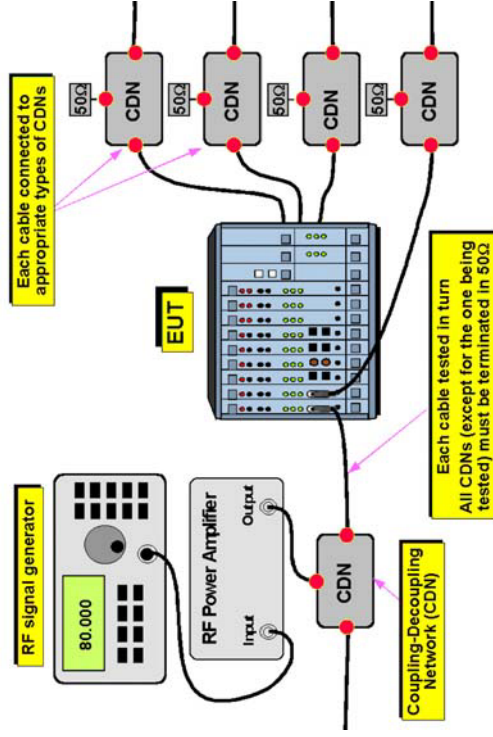

As is usual with EMC test standards, EN 61000-4-6 requires that equipment be set-up and operated as close as possible to its normal operation in real life. For some equipment this will mean providing electrical, mechanical, hydraulic or pneumatic loads, and high-power three-phase electrical supplies, or supplies of hydraulic or pneumatic power (e.g. compressed air). When testing lift (elevator) drive systems, for instance, it is normal to use a large flywheel which has a moment of inertia similar to that of a loaded lift car.

EN 61000-4-6:1996 does not show how to deal with large equipment which has cables that enter high above the floor. If the injection devices are located close to the ground plane, as usual, they can then be too far away from the cables port on the equipment. However, an IEC draft exists (77B/406/CDV dated 5th December 2003) which will modify EN 61000-4-6 to describe how to deal with such equipment.

Essentially, additional horizontal or vertical ground reference planes (GRPs) are

added, connected to the main GRP, so that the injection devices can be located close to the cable port. The closing date for comments was 7th May 2004, so maybe this modification will soon be published in the full standard.

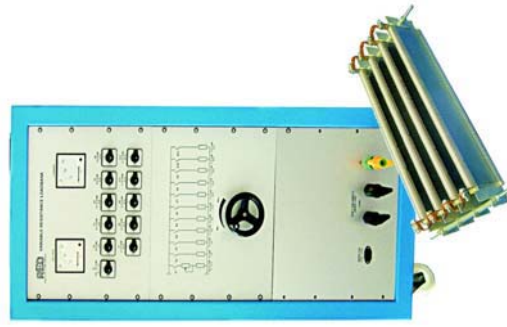

REO can create custom loads to meet any requirements

### Monitoring the EUT for performance degradation during and after the tests

The functional performance degradation allowed during and after the tests may be specified by product or generic standards. Lacking these, the results should be evaluated according to Clause 9 of EN 61000-4-6 (see later).

Well before the tests are begun, the functional specifications for the EUT should be defined, and serious thought should be given to how to monitor its performance both *during* and *after* the tests, as required by EN 61000-4-6. The performance monitoring should achieve sufficient levels of accuracy and repeatability to be sure that the functional specifications are actually being met. This exercise helps determine in advance whether any special testing arrangements need to be organised, equipment hired, special cables and leads made up, etc., etc., well in advance of the actual testing.

Some types of auxiliary equipment (required to exercise the EUT as if in real operation), or functional test equipment can be upset by the conducted RF testing of an EUT. A professional EMC test laboratory should be able to provide basic electrical test instruments that are immune enough to the influences of EMC immunity tests (check with them first). But when auxiliary equipment and test instruments are provided by the manufacturer (e.g. signal or distortion analysers, display screens, computers, etc.) long periods of time can be required trying to decide whether it is the EUT or the test equipment that is failing, all the while burning money at premium test laboratory rates.

Also, test laboratories book their time weeks (or even months) in advance, allocating customers testing timeslots that *should* be long enough to perform the required tests. Where customer-supplied functional test equipment is upset by EMC immunity tests, and no quick fixes seem to work, it is possible to run out of time trying to fix the susceptibility of the auxiliary or test equipment, then having to wait a few weeks (maybe months) until another time-slot can be booked to test the EUT.

### Test conditions

Clause 8 of EN 61000-4-6 states that the EUT shall be tested within its intended operating and climatic conditions, and that temperature and relative humidity should be recorded in the Test Report. Product and generic standards committees might impose other climatic conditions when they call up this basic test standard, if they believe that they could affect the test results.

EN 61000-4-6 does not say so, but the EM environment in which the test is being conducted should not be so severe as to interfere with the EUT and influence the test results. EMC test laboratories should experience no problems with this requirement, but when performing the test in other locations interference might be a possibility. How to deal with interference at the testing location is discussed in a later section.

### The test plan

Clause 8 requires a test plan to be prepared before starting to test an EUT, and for the test plan to be included in the Test Report. In some of the other basic test standards in the EN/IEC 61000-4 series a test plan is optional, but in this case it is a requirement. The following test plan information is required...

- i) The size of the EUT;
- ii) The representative operating conditions of the EUT;
- iii) Whether the EUT is tested as a single or multiple unit;
- iv) The type of test facility used and the positions of the EUT(s), auxiliary equipment and coupling and decoupling devices (i.e. the test transducers) – in effect a description of the test set-up;
- v) The coupling and decoupling devices (test transducers) used and their coupling factors;
- vi) The frequency range of application of the test;
- vii) The rate of sweep of frequency, dwell time and frequency steps;
- viii) The test level to be applied;
- ix) The types of interconnecting cables to be used and the interface port (of the EUT) to which these were connected;
- x) The performance criteria that have been applied;
- xi) A description of the EUT exercising method.

EN 61000-4-6 makes the point that it may be necessary to perform some investigatory testing to establish some aspects of the test plan.

This booklet also recommends that the test plan includes...

- xii) The type designation of the EUT
- xiii) Information on the connections to be made (types of plugs, terminals, etc.) plus information on their corresponding cables and any other accessories (e.g. gender-changers)
- xiv) The operational modes of the EUT for the tests (remembering that each of the EUTs operational modes are to be tested, unless worst-case modes have already been established)

- xv) Descriptions of the auxiliary equipment required to operate the EUT to simulate normal operation (for each of the EUT's operational modes)
- xvi) The descriptions of the equipment used for monitoring the EUT's performance during and after the tests, plus a description of how it is to be set-up and used
- xvii) An explanation of how the uncertainties in the functional tests have been dealt with, to be able to determine whether the functional performance specification (see later) really will be achieved or not during the tests.

All power supply, signal and other functional electrical quantities should be applied within their rated ranges, and this booklet recommends that how this is to be achieved and verified should also be recorded in the test plan.

It is always a good idea to create a test plan well before the planned dates of the tests, to help identify testing and monitoring requirements whilst there still enough time to make changes, hire equipment, perform preliminary tests, etc. This helps to avoid wasting time sorting out unforeseen problems whilst paying premium test laboratory rates.

### The test procedure

The test procedure is very simple: once the EUT and the (verified) test generator are set up as described above, and the equipment required to monitor the operation of the EUT is in place, the EUT is operated in each of its normal modes of operation in turn, fully loaded and connected to auxiliary equipment that simulates its real-life applications. A complete sequence of conducted RF tests is then applied to each cable in turn, as described earlier.

Where there are several modes of operation, the tests are repeated for each mode, unless there is a good technical reason why this is not necessary. For example, a variable speed motor drive may need to be retested if it can be used in different speed control modes (e.g. open-loop, tacho feedback or 'vector'). If any tests are not carried out for good technical reasons, the reasons should be recorded in the Test Report (see later).

This booklet also recommends that the generator's output voltage and voltage waveform are monitored with an oscilloscope *during* the tests to ensure that it remains a low-distortion sine-wave at the required rms voltage at all times. Note that the trained human eye can usually only detect sine-wave distortion on an oscilloscope screen at levels of 2% or more.

### Evaluation of the test results

Clause 9 of EN 61000-4-6 requires the EUT's functional performance during and after each test to be assessed against performance specifications defined by its manufacturer (or the person who requested the test). It recommends that the results be classified according to the following scheme...

- a) Normal performance within the specification limits;
- b) Temporary degradation or loss of function or performance, which is self-recoverable;
- c) Temporary degradation or loss of function or performance which requires operator intervention or system reset;
- d) Degradation or loss of function which is not recoverable due to damage of equipment (components) or software, or loss of data.

EN 61000-4-6 requires that it should be verified that the EUT shows its immunity during the tests as well as afterwards, and in the case of b) and c) that the time interval during which the equipment suffers degraded or lost function or performance shall be recorded.

This classification is offered by EN 61000-4-6 as a guide to immunity standards committees if they call up this basic test method in their product or generic standards. It is very similar to the 'Performance Criteria' A, B, C (and sometimes D) already commonly used in product immunity standards, which first appeared in the generic immunity standards.

### Determining a PASS or a FAIL

Being a basic test method standard, EN 61000-4-6 cannot specify how to determine whether an EUT has passed or failed its tests – but selling an equipment with a data sheet that says it achieves classification d) (see above) is potentially misleading to an uninformed purchaser, and a joke to any purchaser who is familiar with the standard. Classification d) should never be associated with a PASS result.

Equipment expected to operate automatically and unattended for several hours or longer would probably have to achieve a) or b) for a PASS. But if the equipment was always used by an operator, it might be possible to claim a PASS result when its performance on the immunity tests was c) – unless they could be so very unskilled that they could not be expected to know how to restore normal operation – in which case a) or b) would be required.

If the consequences of momentary errors or non-functionality were considered to be very undesirable, a) might be the only

option. But if the consequences were acceptable, then b) or c) might be considered a PASS.

EN 61000-4-6 requires that the EUT not become dangerous or unsafe as a result of its tests. Although not mentioned this booklet also recommends that a FAIL result is recorded if the EUT emits any smoke or vapour, or otherwise displays any behaviour that is clearly unacceptable – even if the issue concerned is not covered in the agreed performance specification.

### Test Report

The point of a Test Report is that it should allow the test to be replicated *exactly*, by anyone, at any time in the future. So any information needed to achieve this should be included in it. It may only be necessary to reference other documents (such as calibration records for the test equipment) and not include them in the Test Report – as long as the information in the Test Report allows all the necessary information to be discovered.

There are numerous references throughout EN 61000-4-6 to what should be included in the Test Report, especially Clause 8. But although the title of Clause 9 includes the words 'Test Report' it does not include a list of requirements.

Clause 8 requires the Test Report to include the Test Plan information it lists (see i) – xi) in the 'test plan' list above), and also to include the test conditions and test results (including the time taken to recover from any degradation or loss of function or performance, see earlier), and a statement of calibration.

This booklet recommends also including in the Test Report items xii) – xvii) in the 'test plan' list above, plus the following:

- Identification of the EUT, e.g. brand name, product type, serial number, software version, etc.
- Identification of the auxiliary and test equipment, e.g. brand name, product type, serial number
- Any special environmental conditions in which the test was performed, e.g. inside a shielded enclosure
- Any specific conditions necessary to enable the test to be performed
- The performance specifications defined by the manufacturer, the requestor of the test, or the purchaser
- Any effects on the EUT observed *during* or *after* the application of the test disturbances, and the duration for which these effects persisted
- The rationale for the pass/fail decision (based on the performance criterion specified in the generic, product or product-family standard, or agreed between the manufacturer and the purchaser, or other person who requested the test)
- Anything that was required to achieve compliance, for example specific condition of use; connector type, cable type and/or maximum length; additional shielding, suppression, filtering or grounding; or specific operating conditions

It also is a good idea to include details of the test generator's routine verification (ideally daily) in the report, plus a judgement on whether the test generator was functioning correctly *before* and *during* the tests, either in the Test Report or in some other QA controlled document.

### A selection of typical REO Filters for AC supplies

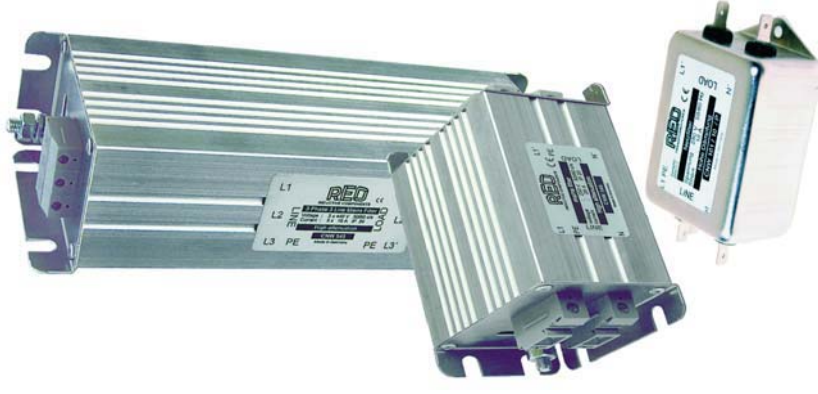

Test laboratories doing full compliance tests to EN 61000-4-6 would perform the tests inside a shielded chamber, with specified distances between the metal walls and the EUT to control the stray coupling. But conducted RF immunity tests are often done outside such chambers or on-site (e.g. for diagnostics or when collecting test evidence to support a Technical Construction File for a large system or an installation).

Of course, the product being tested must operate properly in the first place, and if you are testing on a site that suffers from high levels of electromagnetic 'noise' it may be necessary to use filtering and shielding techniques to be able to distinguish between the effects of the ambient noise and the effects of the test. If this is the case, there are a number of issues that will need to be taken into account to suppress the interfering frequencies effectively. Suitable filtering and shielding techniques are described in [19].

An issue that is often overlooked is that the cables and EUTs that are having RF voltages and currents injected into them during the test will radiate some of this into the air, possibly causing an interference nuisance. Some people are of the opinion that all such testing should only be done when a suitable licence has been granted by the appropriate authorities. So shielding and filtering techniques may also be required to prevent interference from occurring.

**Important Safety Note:** Care should always be taken not to perform conducted RF immunity testing, whether to EN 61000-4-6 or any other method, if there is a possibility that it could cause interference resulting in a costly equipment failure or increased safety risks to people.

If working on exposed live equipment an isolating transformer may be able to be used to help reduce electric shock hazards. It is best to choose special 'high isolation' types of transformers, which have a very low value of primary-to-secondary capacitance, plus choose transformers that are rated for the likely surge levels (at least 6kV, using the IEC 61000-4-5 test method) to help ensure safety.

### REO isolating transformer with low primary to secondary capacitances



**Important Safety Note:** Always take all safety precautions when working with hazardous voltages, such as 230V or 400V (3-phase) electricity. If you are not quite certain about all of these precautions obtain – and follow the guidance of an electrical “health and safety at work” expert. When constructing equipment that employs hazardous voltages, always fully apply the latest versions of the relevant parts of EN 61010-1, at least.

Testing using alternative methods from those in EN 61000-4-6 cannot give any confidence that “full-compliance” tests for conducted RF immunity would be passed. But such non-compliant tests may be valuable for improving the reliability of a product, especially if they simulate the conducted RF voltages and currents that could be present in its real-life electromagnetic environments.

Many equipment rental companies have stocks of the calibrated test gear needed to do conducted RF immunity tests properly, and will rent them out for daily, weekly, or monthly periods. So the easiest way to perform these tests with reasonable accuracy and lowest cost is often to hire the equipment and do the tests yourself.

The test set-ups for conducted RF immunity are not difficult to achieve in a typical manufacturing company, as they don't necessarily have to be performed in special test chambers – but see the notes above about shielding and filtering possibly being needed to prevent the test from causing interference.

Saving money on test labs by doing testing yourself requires skill and attention to detail. RF testing, especially above 100MHz, is difficult enough to do accurately even on a purpose-built test site. So the more money it is desired to save, the greater will be the skill and attention to detail required.

Some rental companies sell off their rental equipment after a few years, and second-hand test gear is also available from a number of other sources. An un-expired calibration certificate on a second-hand purchase is well worth having, if only because it makes the possibility of expensive repairs to achieve your first calibration less likely.

When buying second-hand immunity test gear it is very important indeed to check that it is capable of testing the versions of the standards that you need to use. Some of the test gear is only available second-hand because it is not capable of performing compliant tests to the latest versions of the relevant immunity standards. Such equipment should cost less than compliant test gear, and may still be useful for preliminary investigations where money is tight.

Most of the generic, product, or product-family immunity standards that call up EN 61000-4-6 only require conducted RF immunity testing on ports which attach to cables which could be longer than 1 metre (say). The 1m cable length comes from the fact that at the upper frequency selected for the test, usually 80MHz (the point where radiated immunity testing takes over) – a cable shorter than 1m long is just too short to be fully resonant.

But even the shortest cable can suffer from large amounts of conducted RF voltages and currents if it is connected to other equipment. The conducted RF might be created by the other item of equipment itself, or it could have passed through the other equipment from long cables that are attached to it. Also, if conducted RF immunity testing is employed at frequencies above 80MHz, the corresponding cable length below which resonant effects might be able to be disregarded also shrinks. For example, at 230MHz a resonant cable can be just 326mm long.

So this handbook recommends that, to help meet the Protection Requirements of the EMC Directive – and/or to help achieve reliable products to reduce warranty costs and keep customers happily returning to buy more products – it is best to test *all* signal ports that could be connected to other equipment for their conducted RF immunity with the relevant level and frequency range. It is also recommended that all ports that could connect to cables long enough to be resonant at the highest frequency to be tested using the conducted test methods, are also tested.



A product that passes a test to EN 61000-4-6 can probably be assumed to be more immune to RF fields between 150kHz and 80MHz than one that fails the same test – but passing a test to EN 61000-4-6 does not prove that a product is sufficiently immune to conducted RF in its operational EM environment.

To have sufficient confidence that a product will be sufficiently immune, it is first necessary to assess its worst-case EM environment over the period for which reliable operation is required – then apply appropriate EM design, verification and test techniques. Guidance on assessing an EM environment can be found in [22].

It is not generally possible to simulate all the possibilities of the real-life EM environment, because of timescale and financial limitations. However, final tests should attempt to simulate the major features of the real-life EM environment, for them to provide any confidence at all. We might call this approach: TARL, short for Test As Real Life.

The types of conducted RF noise that EN 61000-4-6 does not test for include the following ....

- Modulation frequencies other than 1kHz. The modulation frequency of an RF threat is very important indeed – when it is close to one of the product's internal operating frequencies (or their harmonics) susceptibility can increase by 20dB, 40dB or possibly more. Internal operating frequencies include digital clocks, tape bias oscillators, RF oscillators (including flyback generators in TVs and VDU monitors), and the entire bandwidths of any analogue circuits.

For equipment with a low-frequency response (e.g. monitoring and/or control of physical parameters or physical objects) testing by keying the RF (i.e. pulsing it OFF and ON again) at a low rate (e.g. 1Hz) can be very revealing, and such a test is used by EN 60601-1-2 for medical instruments that measure physiological parameters.

An appropriate TARL method that is already used in the aircraft industry is described in section 20 of RTCA DO-160E [23]. The conducted RF noise is injected into the cable using an appropriate transducer, and the frequency range to be tested (generally 10kHz - 400MHz) is covered in a series of small frequency steps. At each step the modulation frequency is swept ('chirped') over the whole range of frequencies over which an analysis of the product has shown it could be 'especially sensitive'. The rate of the modulation 'chirp' depends on the response times of the product functions being tested.

The upper limit of the modulation frequency need be no higher than the lowest RF frequency tested. Some companies inject RF into their circuits to discover what internal frequencies they can be susceptible to, then test with those frequencies rather than a full-sweep chirp, to save time.

Also at each frequency step, the RF waveform is applied unmodulated for a time, and then switched OFF and ON again at a 1Hz rate with a 50% mark-space ratio. In each case the test is applied for long enough for the EUT functions concerned to respond significantly.

- Modulation types other than amplitude modulation. A wide variety of analogue and digital RF modulation schemes are now in use, and some of them have different effects on EUTs than the same level of RF at the same frequency using amplitude modulation.
- Differential RF noise currents and voltages – such as can be generated by digital and switch-mode processes inside equipment attached to the EUT by a cable.
- Multiple simultaneous threats. RF exposure tends to occur for long periods of time, and during those periods mains transients, electro-static discharge, and other transient EM disturbances can occur. [24] shows that an EUT's immunity during such simultaneous EM threats can be much less than when one threat is applied at a time. But all testing to IEC/EN immunity standards assumes one threat at a time.
- High levels of RF. Close to a powerful RF transmitter, the RF field strength can be much higher than the 1V/m, 3V/m or 10V/m (in industrial locations) assumed by EN 61000-4-6. Within 100mm of a cellphone antenna the field strength can exceed 30V/m, and at this distance from more powerful handheld transmitters (e.g. as used by private mobile radio systems, emergency services, CB and Amateur Radio enthusiasts) the fields will be even higher still. Within a few metres of a vehicle-mounted transmitter, fields can be higher than 100V/m (especially the illegal high-power CB transmitters used by some truckers, which can generate 150V/m at a distance of around 3m). Close to fixed radio and TV transmitters, and "ISM" equipment used for RF processing materials in industry and medicine, fields can exceed 1kV/m.
- Frequencies above 80MHz. It is usually assumed that conducted testing using the methods in EN 61000-4-6 adequately covers immunity below 80MHz, and that radiated testing using the methods in EN 61000-4-3 adequately covers immunity above 80MHz. But this is a crude demarcation that cannot be correct for every type of EUT. So it is a good idea to include an overlap in the frequency ranges covered by the conducted and radiated testing. For example, DO-160E [23] tests conducted susceptibility from 10kHz to 400MHz, and radiated susceptibility from 100MHz to 18GHz – with an overlap between 100 and 400MHz over which both types of tests are performed.
- Frequencies below 150kHz. There are many sources of RF noise below 150kHz, such as commutator (d.c.) motors, variable-speed a.c. and d.c. motors drives based on pulse-width modulation, energy controls using phase-angle or burst-fired control, switch-mode power converters (both off-line and DC/DC, including the so-called 'electronic transformers' used in domestic low-voltage lighting), and mains rectifiers. Many of these emit a comb of frequencies based on their switching rate. Below 150kHz, EN 61000-4-16 would normally be used instead of EN 61000-4-6, but this is once again a common-mode test method, and a lot of the noise sources at these low frequencies can give rise to differential-mode noise.
- Testing at lower levels. All types of semiconductor circuits of all types behave non-linearly when exposed to RF – so it is possible for a circuit to suffer errors or malfunctions at a low

level of exposure, whilst operating as intended at the maximum test level. This fact is recognised by most of the transient test methods in the 61000-4 series, but not by its continuous test method standards (such as EN 61000-4-6). Lower level EM threats are more common than high level ones, so testing with lower levels, as well as at the maximum, could help ensure reliable operation.

- Intentional RF threats. Some manufacturers will need to worry about the possibility of bad people trying to interfere with their products, and this has been a big concern for gambling machinery manufacturers for many years. The IEC is beginning to publish standards describing these types of threats, and how to test for them, in its 61000-5 series of standards. IEC 61000-5-1 provides an introduction to this issue, including a table showing the types of threats and their amplitudes and frequencies.

Finally, the issue of multiple threat frequencies needs to be considered. Near any radio or TV broadcast antenna or RF communications base station there will be multiple RF threat frequencies at the same time. Examples of other possibly simultaneous RF sources in a typical modern home, office, or roadside include microwave cookers, Wi-Fi and Bluetooth transmitters, and cellphones. In medical and industrial locations, and also in/near beauty salons using depilators there can also be significant RF threats from "ISM" equipment (covered by the scope of CIPSR 11 or EN 55011) that use RF energy to process materials.

Conducted noise from connected equipment will be present at multiple frequencies – switch-mode power converters and digital clocks generate a comb of frequencies based on their switching rate. Many modern products have multiple digital clocks, and multiple off-line and DC/DC switch-mode converters, each of them emitting a comb of frequencies. The modulation of a given RF frequency will often contain two or more frequencies simultaneously, resulting in multiple demodulated frequencies inside the EUT. Intermodulation between multiple RF sources will result in many new frequencies being generated inside the EUT. Demodulation and intermodulation frequencies can occur over the whole spectrum from d.c. to GHz, and at the low frequency end can cause problems for low-frequency instrumentation and audio-frequency functions.

So there are many possible ways in which two or more of an EUT's especially sensitive internal frequencies could be interfered with in real life. Testing over the whole range with a single RF frequency, using single frequency modulation (even if chirped, as above) does not test such possibilities, which could have different interference behaviour.

This is one area in which increased testing is not a viable option – because the tests would take much too long and cost much too much. But if the conducted RF testing is performed as described above, using ...

- Test levels and RF frequencies that exceed the worst-case operational EM environment, by the amount of the measurement uncertainty plus the variation in unit-to-unit EMC performance (at least)

- RF and/or modulation frequencies that correspond to all of the 'especially sensitive frequencies' used by the EUT
- EUT exercising methods that check *all* functions remain capable of operating correctly throughout the tests, as described in the section on 'Exercising the EUT during the tests' earlier. It may instead be acceptable in some circumstances for just the protective functions (e.g. 'alarm', 'safe shut down', etc.) to remain capable of operating correctly throughout the tests.

...then there is a good chance that problems due to multiple interference with the EUT's 'especially sensitive frequencies', will not occur in real life. But it can be hard to know if the worst-case EM environment has been correctly assessed, and complex circuits can sometimes behave in unforeseen ways when interfered with, so where high reliability or safety is required it is recommended to design the EUT so as to ensure that multiple simultaneous interferences will not result in a problematic outcome.

- [1] IEC 61000-4-6:1996 "Electromagnetic Compatibility (EMC) – Part 4: Testing and Measurement Techniques – Section 6: Immunity to Conducted Disturbances, Induced by Radio Frequency Fields"
- [2] EN 61000-4-6:1996 "Electromagnetic Compatibility (EMC) – Part 4: Testing and Measurement Techniques – Section 6: Immunity to Conducted Disturbances, Induced by Radio Frequency Fields"
- [3] European Union Directive 89/336/EEC (as amended) on Electromagnetic Compatibility. The Directive's official EU homepage includes a downloadable version of the EMC Directive; a table of all the EN standards listed under the Directive; a guidance document on how to apply the Directive; lists of appointed EMC Competent Bodies; and progress on the 2<sup>nd</sup> Edition EMC Directive; all at: [http://europa.eu.int/comm/enterprise/electr\\_equipment/emc/index.htm](http://europa.eu.int/comm/enterprise/electr_equipment/emc/index.htm).
- [4] The IEE's 2000 guide: "EMC & Functional Safety", can be downloaded as a 'Core' document plus nine 'Industry Annexes' from <http://www.iee.org/Policy/Areas/Emc/index.cfm>. It is recommended that everyone downloads the 'Core' document and at least reads its first few pages. Complying with this IEE guide could reduce exposure to liability claims.
- [5] "EMC-related Functional Safety – An Update", Keith Armstrong, EMC & Compliance Journal, Issue No. 44, January 2003, pp 24-30, on-line at: <http://www.compliance-club.com/KeithArmstrongPortfolio>.
- [6] Visit <http://www.brookmans.com> and Search for 'Interference at Brookmans Park'. Also visit <http://website.lineone.net/~greenbelt/BP%20Transmit.htm>
- [7] Examples of interference from broadcasting transmitters can be found in the "Banana Skins Compendium", via a link from [www.compliance-club.com](http://www.compliance-club.com) or at: <http://www.compliance-club.com/archive1/Bananaskins.htm>, especially (at the time of writing) numbers: 142, 143, 251 and 252.
- [8] "Two Dimensional Simulation and Measurement of the Coupling of Bluetooth Signals Into Conductive Structures", A.Schoof, T. Stadler, J.L. ter Haseborg, IEEE 2003 EMC Symposium, Boston, August 2003, Symposium Record ISBN:0-7803-7835-0 pp 258-262.
- [9] "Electromagnetic Compatibility Aspects of Radio-based Mobile Telecommunications Systems" final report, LINK Personal Communications Programme, University of York <http://www.emc.york.ac.uk/reports/linkpcp/contents.html>
- [10] "Why EMC Testing is Inadequate for Functional Safety", Keith Armstrong, IEEE 2004 International EMC Symposium, Santa Clara, August 9-13 2004. Also: Conformity magazine, March 2005 pp 15-23, downloadable via <http://www.conformity.com>.
- [11] "The IEE's Training Course on EMC for Functional Safety (also for high-reliability and legal metrology)", visit <http://www.iee.org> for their event calendar to check the date of the next course. If no courses are listed contact the IEE's Functional Safety Professional Network (via the same IEE homepage) and ask.
- [12] "EMC Testing Part 1 – Radiated Emissions", Tim Williams and Keith Armstrong, EMC & Compliance Journal February 2001. On-line at <http://www.compliance-club.com/KeithArmstrongPortfolio>.
- [13] "EMC Testing Part 4 – Radiated Immunity", Tim Williams and Keith Armstrong, EMC & Compliance Journal, August 2001 and October 2001. On-line at <http://www.compliance-club.com/KeithArmstrongPortfolio>
- [14] "Chamber Exit Filters for Radiated EMC Testing" Richard Marshall, EMC 2000 Conference, York 10/11 July 2000, <http://www.yorkemc.co.uk>. Information on these filters also at: <http://www.design-emc.co.uk>.
- [15] "The EM-Clamp as Economically Feasible Tool for Susceptibility Analysis", N. Monteyne and J. Catrysse, EMC Europe 2000 Symposium, Brugge, Sep 11-15 2000, ISBN 90-76019-14-2.
- [16] "Desk-top Immunity Testing and Diagnostics" Richard Marshall, IEE Colloquium on 'In-House EMC Measurements and Diagnostics', Savoy Place London 14th November 2000, IEE Reference: 00/092 (sales@iee.org.uk)
- [17] "A New Approach to Coupling/Decoupling Networks for EMC Testing" R C Marshall, York EMC 99, July 1999.
- [18] "Subjecting Failure Modes in Immunity Tests to Uncertainty Analysis". Brian Jones, The EMC & Compliance Journal, June 1997, Pages 7-10, [www.compliance-club.com](http://www.compliance-club.com).
- [19] "EMC for Systems and Installations", Tim Williams and Keith Armstrong, Newnes 2000, ISBN 0-7506-4167-3
- [20] "EMC Testing On-site", Dag Björklöf, Compliance Engineering magazine, September/October 1997, pages 73-79 in their US edition, 41-45 in their European edition.
- [21] "EMC for Systems and Installations – Part 4 – Filtering and Shielding", Keith Armstrong, EMC & Compliance Journal, August 2000, pages 17-26, <http://www.compliance-club.com/KeithArmstrongPortfolio>.
- [22] "Assessing an EM Environment", Keith Armstrong, download from the 'Publications and Downloads' page at <http://www.cherryclough.com>.
- [23] "Environmental Conditions and Test Procedures for Airborne Equipment", RTCA/DO-160E, December 9<sup>th</sup> 2004, <http://www.rtca.org>
- [24] "Combined Effects of Several, Simultaneous, EM Couplings", Michel Mardiguian, 2000 IEEE International Symposium on EMC, Washington D.C., August 21-25 2000, ISBN 0-7803-5680-2, pp. 181-184.
- EN and IEC standards may be purchased from the British Standards Institution (BSI) at: [orders@bsi-global.com](mailto:orders@bsi-global.com). To enquire about a product or service call BSI Customer Services on +44 (0)20 8996 9001 or e-mail them at [cservices@bsi-global.com](mailto:cservices@bsi-global.com). IEC standards may be purchased with a credit card from the on-line bookstore at [www.iec.ch](http://www.iec.ch), and many of them can be delivered by email within the hour.



**Keith Armstrong from Cherry Clough Associates**

This guide is one of a series. You can request all published and future guides by sending an email to [main@reo.co.uk](mailto:main@reo.co.uk) or from our website at [www.reo.co.uk](http://www.reo.co.uk)

Keith Armstrong graduated in electrical engineering with a B.Sc (Hons.) from Imperial College London in 1972, majoring in analogue circuit design and electromagnetic field theory, with a Upper Second Class Honours (Cum Laude). Much of his life since then has involved controlling real-life interference problems in high-technology products, systems, and installations, for a variety of companies and organisations in a range of industries.

Keith has been a Chartered Electrical Engineer (UK) since 1978, a Group 1 European Engineer since 1988, and has written and presented a great many papers on EMC. He is a past chairman of the IEE's Professional Group (E2) on Electromagnetic Compatibility, is a member of the IEEE's EMC Society, and chairs the IEE's Working Group on 'EMC and Functional Safety'.

Contact: Keith Armstrong by email at [keith.armstrong@cherryclough.com](mailto:keith.armstrong@cherryclough.com) or visit the Cherry Clough website [www.cherryclough.com](http://www.cherryclough.com)

#### **Acknowledgements**

Some of the material was previously published in 2001-2002 in the EMC Compliance Journal's series "EMC Testing": <http://www.compliance-club.com> or <http://www.compliance-club.com/KeithArmstrongPortfolio>.

Many thanks are due to Tim Williams of Elmac Services: <http://www.elmac.co.uk>; [timw@elmac.co.uk](mailto:timw@elmac.co.uk), my co-author for that series

REO is an original manufacturer of high quality power equipment, including electronic controllers, components and electrical regulators, all backed by the application expertise demanded by specialised, industrial sectors, such as .....

Controllers designed specifically for use in the parts and materials handling industry, together with a wide range of electromagnets for driving vibratory feeders.

Power controllers for adjusting and regulating voltage, current, frequency or power, as well as its long established variable transformers (variacs) up to 1MVA and sliding resistors of all types. These are complemented by a range of modern, electronic, variable power supplies.

Components for adapting variable speed drives employed in non-standard applications; including inductors, EMC filters and braking resistors. The range of inductive devices extends into railway components for electrical traction and rolling stock, which includes chokes and high-frequency transformers.

Special, toroidal transformers used in safety, medical and energy-saving systems plus high-frequency transformers used in switch-mode power supplies.

Test equipment such as load banks and variable AC/DC power supplies,

REO actively searches for development partners, particularly in niche markets, and considers this to be an essential stimulus for creating new and original ideas.

#### **CNW102**

Single phase,  
250 V,  
high performance  
unit suitable for  
most applications



#### **CNW104**

3 phase,  
3 x 440 V,  
3 line mains filter  
with very high  
attenuation



#### **CNW114**

3 phase,  
3 line mains filter  
with increased  
attenuation



#### **CNW203**

3 phase,  
3 x 480 V  
bookcase style  
filters, with very  
high attenuation



## KEU - MARKET SECTORS



Train Systems

Chokes and high frequency transformers

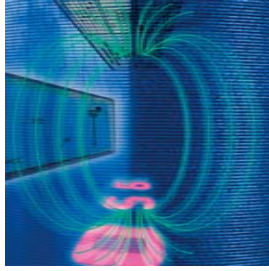

Test Systems

Power supplies and load banks



Drive Systems

Filters and braking resistors

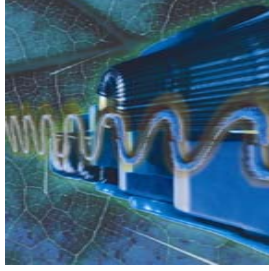

Inductive Components

Chokes, resistors and transformers

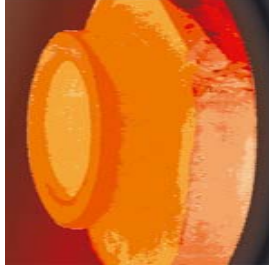

Power Electronics

Phase-angle and frequency controllers



Medical Systems

Medical Transformers



Automation Systems

Controllers for vibratory feeders



Classics

Rheostats and variacs



Motor Control Systems

Soft-starts



Communication Systems

Field bus and gsm

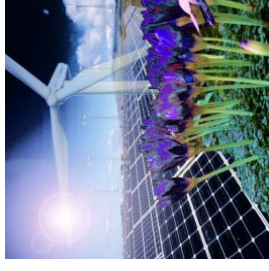

Renewable Systems

Solar transformers